

Criteria 1

Criterion 1 – Curricular Aspects

Key Indicator- 1.2

1.2 Academic Flexibility

1.2.1 Number of Certificate/Value added courses offered and online courses of MOOCs, SWAYAM, NPTEL etc. where the students of the institution have enrolled and successfully completed during the last five years)

ACADEMIC YEAR 2018-2019

ADD ONCOURSE/WORK SHOP/CERTIFICATE COURSES

Sl.No	Description	Page No.
1	Add on Course on Analysis of Structures using STAAD Pro-CIVIL	1-22
2	Workshop on Building Drawing-CIVIL	23-40
3	Add on Course on Java Programming-CSE	41-62
4	Work shop on Python Programming	63-80
5	Add on Course on Embedded Building Blocks Using Arudino Hands on for Young-ECE	81-123
6	Python Programming for Power Electronics-EEE	124-144
7	Workshop on CATIA-MECH	145-182

30.01.2019

Chennai

From

The HOD-CIVIL,
Peri Institute of Technology
Mannivakkam,
Chennai-48

To

The Principal
PERI Institute of Technology
Chennai

Sir,

[Sub: Approval to conduct a program on **CC08 - Analysis of Structures using STAAD Pro** Reg]

The department of Civil Engineering is planning to conduct a program titled "**CC08 - Analysis of Structures using STAAD Pro**" training for Civil Engineering students. Kindly accord permission for conducting the program.

S.No.	Year	Scheduled Date	Time
1	III,IV	11-02-2019 to 15-02-2019	8.30a.m to 3.40p.m

Thanking You

Yours Truly

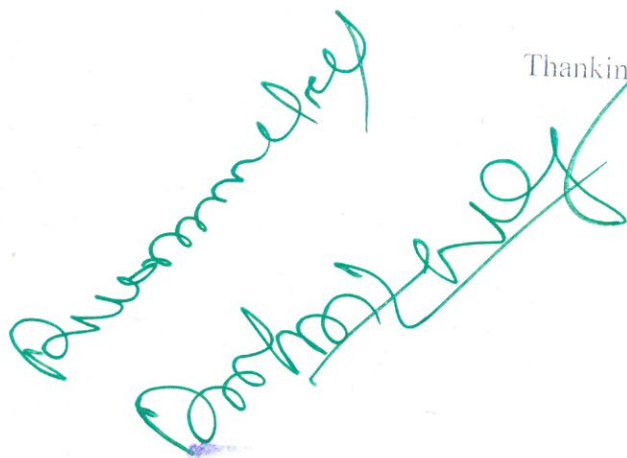

Dr. R. PALSON KENNEDY, M.E., Ph.D.,
PRINCIPAL
PERI INSTITUTE OF TECHNOLOGY
Mannivakkam, Chennai - 600 048.

HOD/CIVIL
Head of the Department
Department of Civil Engineering
PERI Institute of Technology,
Mannivakkam, Chennai - 600 048

DEPARTMENT OF CIVIL ENGINEERING

ACADEMIC YEAR 2018-2019

PERIIT /CIVIL/Add on Course /2018-2019/Even/01

Date: 01.02.2019

CIRCULAR

Department of Civil Engineering is planned to conduct a program titled “CC08 -Analysis of Structures using STAAD Pro ”for the Academic Year 2018 – 2019 for CIVIL Engineering III year,IV year students directed to attend the program.

S.No.	Year	Scheduled Date	session
1	III,IV	11-02-2019 to 15-02-2019	8.30a.m to 3.40p.m

Co-ordinator

Head of the Department
Head of the Department
Department of Civil engineering
PERI Institute of Technology,
Mannivakkam, Chennai - 600 048

Copy To:

1. Principal
2. Vice – Principal
3. IQAC
4. Faculty Members – Civil
5. Main – Notice Board

PERI INSTITUTE OF TECHNOLOGY
DEPARTMENT OF CIVIL ENGINEERING

ACADEMIC YEAR 2018-2019

ADD ON COURSE-CC08 -Analysis of Structures using STAAD Pro

Minutes of the Meeting held on 05.02.2019

Venue : HOD Room, Civil Department, Beta Block,
PERI Institute of Technology

Date : 05.02.2019

Time : 10:00am – 11:30am

Agenda of the Meeting:

1. Syllabus preparation
2. Tentative Timetable preparation
3. Assessment method discussion

Members Present:

1. Mr. B. Magesh, Head of the Department, Civil Engineering
2. Ms. C. Lavanya, VAC Coordinator, Civil Engineering
- 3 Mr. K.Rajaraman, Industrial Expert, Shoba Constructions, Bangalore

Ms. C. Lavanya, VAC Coordinator welcomed and briefed the consultative committee members about the meeting. The guidelines prescribed for Value Added Courses by Anna University are disseminated to the consultative committee members.

Agenda Item 1: Syllabus preparation

The syllabus is framed in accordance with the view to achieve the desired outcomes of the course. The courses similar to the selected course in the curriculum of UG and PG programmes offered by various IITs, NITs, Anna University and other Universities has been analysed and final syllabus is framed by the consultative committee members.

Agenda Item 2: Tentative Timetable preparation

The Timetable for Add on Course classes and Internal Assessment is prepared based on guidelines prescribed by Anna University. Total of 40 hours from 11-02-2019 to 15-02-2019 is decided and communicated to the Course faculty.

Agenda Item 3: Assessment method

Internal assessments to be conducted only at the end of the course is decided. Internal Assessment is decided to be conducted for Analysis of structure for load combination

Part A – Analysis of given structure using Staad pro – 1*30 = 30 marks



Coordinator
5/2/19

Senior Faculty Member
5/9/19

K. P. Jagan
Industry Expert
5/2/19

Hod - Civil Engg

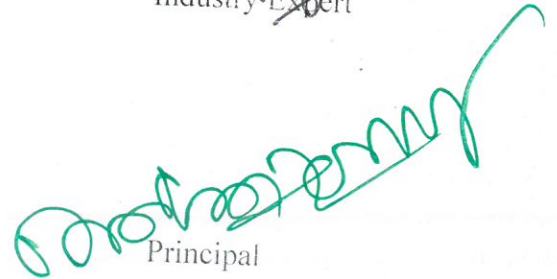
Head of the Department
Department of Civil Engineering
PERI Institute of Technology,
Mannivakkam, Chennai - 600 048

Principal

Dr. R. PALSON KENNEDY, M.E., Ph.D.,
PRINCIPAL
PERI INSTITUTE OF TECHNOLOGY
Mannivakkam, Chennai - 600 048.

DEPARTMENT OF CIVIL ENGINEERING

ACADEMIC YEAR 2018-2019

ADD ON COURSE

SYLLABUS CC008 -Analysis of Structures using STAAD Pro

MODULE 1

Overview of Structural Analysis and Design.Introduction to STAAD Pro. V8i
Getting Pro. Workspace.Staad Editor,Structure Wizard.Creating a New Project and
Units.Introduction to File. Edit. View. Selection. Geometry. Commands. Analyze.
Mode.Introduction to Snap Node/Beam.Insert Node and Add Beam.Introduction to
Setup. Geometry. General. Analysis/Print and Design.Assigning Properties.Assigning
Supports.Group Specification

MODULE 2

Assigning Load.Structure Analysis,Material Specification,Loading,Introduction to
Analysis.Perform Analysis,Overview of Output Page.Pre-analysis and Post-analysis
Print

MODULE 3

General Guideline for Design.Column and Beam Design .Reinforced Concrete Design

MODULE 4

Truss Analysis.Roof Truss Analysis.Bridge Truss Analysis,Multi-storied building
frame

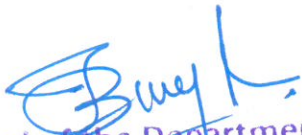
Head of the Department
Department of Civil Engineering
PERI Institute of Technology,
Mambakkam, Chennai - 600 048

DEPARTMENT OF CIVIL ENGINEERING

ACADEMIC YEAR 2018-2019

ADD ON COURSE-TIME TABLE

CC008 -Analysis of Structures using STAAD Pro

S.No	Date	Hours	Topics
1	11.02.2019	1-8	Overview of Structural Analysis and Design, Introduction to STAAD Pro. V8i Getting Pro. Workspace, Staad Editor, Structure Wizard, Creating a New Project and Units, Introduction to File, Edit, View, Selection, Geometry, Commands, Analyze, Mode, Introduction to Snap Node/Beam, Insert Node and Add Beam, Introduction to Setup, Geometry, General, Analysis/Print and Design, Assigning Properties, Assigning Supports, Group Specification
2	12.02.2019	1-8	Assigning Load, Structure Analysis, Material Specification, Loading, Introduction to Analysis, Perform Analysis, Overview of Output Page, Pre-analysis and Post-analysis Print
3	13.02.2019	1-8	General Guideline for Design, Column and Beam Design, Reinforced Concrete Design
4	14.02.2019	1-8	Truss Analysis, Roof Truss Analysis, Bridge Truss Analysis
5	15.02.2019	1-8	Multi-storied building frame, Internal assesment

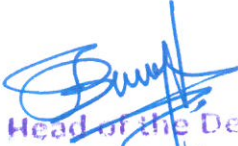
Head of the Department
Department of Civil Engineering
PERI Institute of Technology,
Manniyakkam, Chennai - 660 048

DEPARTMENT OF CIVIL ENGINEERING

ACADEMIC YEAR 2018-2019

ADD ON COURSE

CC008 Analysis of Structures using STAAD Pro

STUDENTS LIST

Final Years		
S. No.	Reg. No.	Name of the Students
1	411515103001	Aakash S
2	411515103003	Abirami Yazhini G
3	411515103004	Ajay Kanna K
4	411515103005	Ajith Kumar C
5	411515103006	Ajith Kumar D
6	411515103008	Ajith Kumar M
7	411515103009	Ajith Kumar R
8	411515103010	Akash A
9	411515103011	Akileshwaran K P
10	411515103012	Anantha Krishnan R
11	411515103013	Anirudhan R
12	411515103015	Aravind T
13	411515103016	Arunachalam R
14	411515103017	Arunkumar R
15	411515103018	Arun Kumar M
16	411515103019	Athish R R
17	411515103021	Balachandar K
18	411515103022	Balaji K
19	411515103023	Balaji K V

20	411515103024	Balaji R
21	411515103025	Barath M
22	411515103026	Bharath P
23	411515103027	Boobalan S
24	411515103028	Boomiga N
25	411515103029	Chandra Pandian C
26	411515103030	Dakshnamoorthy R
27	411515103031	Deepak Raj S
28	411515103032	Dhanasekar K
29	411515103033	Dinesh M
30	411515103034	Divaker D
31	411515103035	Fajjur Rahman B
32	411515103036	Gunanithi S
33	411515103037	Hariharan N
34	411515103038	Hemananth C S
35	411515103039	Hindhumathi Y
36	411515103040	Iniyavan E P
37	411515103041	Jaikrishna T
38	411515103042	Jaya C S
39	411515103044	Jeevitha N
40	411515103045	Jeyaruban A
41	411515103047	Kaliyamoorthy M
42	411515103048	Kamesh S
43	411515103049	Karthick S
44	411515103050	Kavin Romero George H
45	411515103051	Kaviyarasu R

46	411515103052	Kharatmole Gayathri
47	411515103054	Logesh R
48	411515103055	Lokesh R
49	411515103056	Mahadevan S
50	411515103057	Maniratnam S
51	411515103058	Manivannan R
52	411515103061	Mohan T
53	411515103062	Narendhiran G
54	411515103063	Nirmal Kumar P
55	411515103064	Nithish Raja N
56	411515103066	Parthiban M
57	411515103067	Pavithra D
58	411515103068	Prabhu S
59	411515103069	Praveen R
60	411515103070	Praveen Kumar C
61	411515103071	Pravin Ajho M
62	411515103072	Preethi K
63	411515103075	Ragul R
64	411515103076	Rammohan S
65	411515103077	Ramu R
66	411515103078	Ramya Githanjali S
67	411515103079	Ranjith Kumar N
68	411515103080	Ranjith Kumar P
69	411515103081	Rathna Gowtham R M
70	411515103082	Sasi Kumar R
71	411515103083	Sathish Pandian C

72	411515103084	Selva Ganesh K
73	411515103085	Sharvesh R
74	411515103086	Shre Shinika G
75	411515103088	Sivasakthi R
76	411515103089	Srihari S
77	411515103090	Sriram S
78	411515103091	Subash D
79	411515103092	Subbulakshmi R
80	411515103093	Surya S
81	411515103094	Thamizharasan R
82	411515103095	Thangamuthu M
83	411515103096	Tharvesh Mohaideen
84	411515103097	Veeraselvan P
85	411515103098	Vel Murugan V
86	411515103099	Vidhya S
87	411515103100	Vignesh M
88	411515103101	Vigneshwaran M
89	411515103102	Vigneswaran P
90	411515103103	Yakesh N
91	411515103104	Yuvaraj D
92	411515103105	Yuvaraj K
93	411515103301	Ajithkumar M
94	411515103302	Basilton Immanuel
95	411515103303	Bhavani S
96	411515103304	K.Gokulnath
97	411515103305	Karthick D

98	411515103306	Karthick M
99	411515103307	Priya M
100	411515103308	Santhana Krishnan
Third Years		
101	411516103002	S Anbu Raj
102	411516103003	R Balaji
103	411516103005	M Hariharan
104	411516103006	R Harshavardhan
105	411516103008	P Mohana Krishnan
106	411516103009	A Nishanthi
107	411516103010	K Raja Karuna
108	411516103011	G Sahithyan
109	411516103012	S. Sandeep
110	411516103014	S Sathish
111	411516103016	M. Surya Raj
112	411516103017	M. Vasantha Kumar
113	411516103018	J.J Vignesh
114	411516103019	M. Vinoth
115	411516103021	S Yogeshwaran
116	411516103301	Arif
117	411516103303	K Navikash
118	411516103304	Ram Prasath
119	411516103306	I Viswath Kumar
120	411516103701	K. Bagath Singh
121	411516103702	M.Hariharan

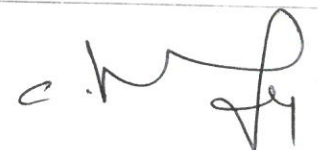

Duration of course:40 Hours

Number of students enrolled in the year:

Third Years

S. No.	Reg. No.	Name of the Students	11.02.2019	12.02.2019	13.02.2019	14.02.2019	15.02.2019
1	411516103002	S Anbu Raj	S. Anbu Raj	S. Anbu Raj	S. Anbu Raj	S. Anbu Raj	S. Anbu Raj
2	411516103003	R Balaji	R. Balaji	R. Balaji	R. Balaji	R. Balaji	R. Balaji
3	411516103005	M Hariharan	M. Hariharan	M. Hariharan	M. Hariharan	M. Hariharan	M. Hariharan
4	411516103006	R Harshavardhan	R. Harshavardhan	R. Harshavardhan	R. Harshavardhan	R. Harshavardhan	R. Harshavardhan
5	411516103008	P Mohana Krishnan	P. Mohana Krishnan	P. Mohana Krishnan	P. Mohana Krishnan	P. Mohana Krishnan	P. Mohana Krishnan
6	411516103009	A Nishanthi	A. Nishanthi	A. Nishanthi	A. Nishanthi	A. Nishanthi	A. Nishanthi
7	411516103010	K Raja Karuna	K. Raja Karuna	K. Raja Karuna	K. Raja Karuna	K. Raja Karuna	K. Raja Karuna
8	411516103011	G Sahithyan	G. Sahithyan	G. Sahithyan	G. Sahithyan	G. Sahithyan	G. Sahithyan
9	411516103012	S. Sandeep	S. Sandeep	S. Sandeep	S. Sandeep	S. Sandeep	S. Sandeep
10	411516103014	S Sathish	S. Sathish	S. Sathish	S. Sathish	S. Sathish	S. Sathish
11	411516103016	M. Surya Raj	M. Surya Raj	M. Surya Raj	M. Surya Raj	M. Surya Raj	M. Surya Raj
12	411516103017	M. Vasantha Kumar	M. Vasantha Kumar	M. Vasantha Kumar	M. Vasantha Kumar	M. Vasantha Kumar	M. Vasantha Kumar
13	411516103018	J.J Vignesh	J.J. Vignesh	J.J. Vignesh	J.J. Vignesh	J.J. Vignesh	J.J. Vignesh
14	411516103019	M. Vinoth	M. Vinoth	M. Vinoth	M. Vinoth	M. Vinoth	M. Vinoth
15	411516103021	S Yogeshwaran	S. Yogeshwaran	S. Yogeshwaran	S. Yogeshwaran	S. Yogeshwaran	S. Yogeshwaran
16	411516103301	Arif	Arif	Arif	Arif	Arif	Arif
17	411516103303	K Navikash	K. Navikash	K. Navikash	K. Navikash	K. Navikash	K. Navikash
18	411516103304	Ram Prasath	Ram Prasath	Ram Prasath	Ram Prasath	Ram Prasath	Ram Prasath
19	411516103306	I Viswath Kumar	I. Viswath Kumar	I. Viswath Kumar	I. Viswath Kumar	I. Viswath Kumar	I. Viswath Kumar
20	411516103701	K. Bagath Singh	K. Bagath Singh	K. Bagath Singh	K. Bagath Singh	K. Bagath Singh	K. Bagath Singh
21	411516103702	M.Hariharan	M. Hariharan	M. Hariharan	M. Hariharan	M. Hariharan	M. Hariharan

(Handwritten signature)

(Handwritten signature in green)

Dr. R. PALSON KENNEDY, M.E., Ph.D.
PRINCIPAL
PERI INSTITUTE OF TECHNOLOGY
Mannivakkam, Chennai - 600 048

DEPARTMENT OF CIVIL ENGINEERING

ADD ON COURSE

Analysis of Structures using STAAD Pro - CC008

ACADEMIC YEAR 2018- 2019

ATTENDANCE SHEET

(11.02.2019 to 15.02.2019)

Duration of course:40 Hours

Number of students enrolled in the year:100

Final Years

S. No.	Reg. No.	Name of the Students	11.02.2019	12.02.2019	13.02.2019	14.02.2019	15.02.2019
1	411515103001	Aakash S	Aakash S	Aakash S	Aakash S	Aakash S	Aakash S
2	411515103003	Abirami Yazhini G	Abi	Abi	Abi	Abi	Abi
3	411515103004	Ajay Kanna K	Ajay K	Ajay K	Ajay K	Ajay K	Ajay K
4	411515103005	Ajith Kumar C	Ajith C	Ajith C	Ajith C	Ajith C	Ajith C
5	411515103006	Ajith Kumar D	Ajith D	Ajith D	Ajith D	Ajith D	Ajith D
6	411515103008	Ajith Kumar M	Ajith M	Ajith M	Ajith M	Ajith M	Ajith M
7	411515103009	Ajith Kumar R	Ajith R	Ajith R	Ajith R	Ajith R	Ajith R
8	411515103010	Akash A	Aakash	Aakash	Aakash	Aakash	Aakash
9	411515103011	Akileshwaran K P	Akilesh	Akilesh	Akilesh	Akilesh	Akilesh
10	411515103012	Anantha Krishnan R	Ananth	Ananth	Ananth	Ananth	Ananth
11	411515103013	Anirudhan R	Anirudh	Anirudh	Anirudh	Anirudh	Anirudh
12	411515103015	Aravind T	Aravind	Aravind	Aravind	Aravind	Aravind
13	411515103016	Arunachalam R	Arun	Arun	Arun	Arun	Arun
14	411515103017	Arun Kumar R	Arun R	Arun R	Arun R	Arun R	Arun R
15	411515103018	Arun Kumar M	Arun M	Arun M	Arun M	Arun M	Arun M
16	411515103019	Atnish R R	Atnish	Atnish	Atnish	Atnish	Atnish
17	411515103021	Balachandar K	Bala	Bala	Bala	Bala	Bala
18	411515103022	Balaji K	Balaji	Balaji	Balaji	Balaji	Balaji
19	411515103023	Balaji K V	Balaji	Balaji	Balaji	Balaji	Balaji
20	411515103024	Balaji R	Balaji R	Balaji R	Balaji R	Balaji R	Balaji R
21	411515103025	Barath M	Barath	Barath	Barath	Barath	Barath
22	411515103026	Bharath P	Bharath	Bharath	Bharath	Bharath	Bharath
23	411515103027	Boobalan S	Boobalan	Boobalan	Boobalan	Boobalan	Boobalan
24	411515103028	Boomiga N	Boomiga	Boomiga	Boomiga	Boomiga	Boomiga
25	411515103029	Chandra Pandian C	Chandra	Chandra	Chandra	Chandra	Chandra
26	411515103030	Dakshnamoorthy R	Daksh	Daksh	Daksh	Daksh	Daksh
27	411515103031	Deepak Raj S	Deepak	Deepak	Deepak	Deepak	Deepak
28	411515103032	Dhanasekar K	Dhanasekar	Dhanasekar	Dhanasekar	Dhanasekar	Dhanasekar
29	411515103033	Dinesh M	Dinesh	Dinesh	Dinesh	Dinesh	Dinesh
30	411515103034	Divaker D	Divaker	Divaker	Divaker	Divaker	Divaker
31	411515103035	Faijuz Rahman B	Faijuz	Faijuz	Faijuz	Faijuz	Faijuz
32	411515103036	Gunanithi S	Gunanithi	Gunanithi	Gunanithi	Gunanithi	Gunanithi
33	411515103037	Hariharan N	Hariharan	Hariharan	Hariharan	Hariharan	Hariharan
34	411515103038	Hemananth C S	HCS	HCS	HCS	HCS	HCS
35	411515103039	Hindhumathi Y	Hindhumathi	Hindhumathi	Hindhumathi	Hindhumathi	Hindhumathi
36	411515103040	Iniyavan E P	Iniyavan	Iniyavan	Iniyavan	Iniyavan	Iniyavan
37	411515103041	Jaikrishna T	Jaikrishna	Jaikrishna	Jaikrishna	Jaikrishna	Jaikrishna
38	411515103042	Jaya C S	Jaya	Jaya	Jaya	Jaya	Jaya
39	411515103044	Jeevitha N	Jeevitha	Jeevitha	Jeevitha	Jeevitha	Jeevitha
40	411515103045	Jeyaruban A	Jeyaruban	Jeyaruban	Jeyaruban	Jeyaruban	Jeyaruban
41	411515103047	Kaliyamoorthy M	Kaliyamoorthy	Kaliyamoorthy	Kaliyamoorthy	Kaliyamoorthy	Kaliyamoorthy
42	411515103048	Kamesh S	Kamesh	Kamesh	Kamesh	Kamesh	Kamesh
43	411515103049	Karthick S	Karthick	Karthick	Karthick	Karthick	Karthick
44	411515103050	Kavin Romero George H	K.R.G	K.R.G	K.R.G	K.R.G	K.R.G
45	411515103051	Kaviyarasu R	Kaviyarasu	Kaviyarasu	Kaviyarasu	Kaviyarasu	Kaviyarasu
46	411515103052	Kharatmole Gayathri	Kharatmole	Kharatmole	Kharatmole	Kharatmole	Kharatmole
47	411515103054	Logesh R	Logesh	Logesh	Logesh	Logesh	Logesh
48	411515103055	Lokesh R	Lokesh	Lokesh	Lokesh	Lokesh	Lokesh
49	411515103056	Mahadevan S	Mahadevan	Mahadevan	Mahadevan	Mahadevan	Mahadevan
50	411515103057	Maniratnam S	Maniratnam	Maniratnam	Maniratnam	Maniratnam	Maniratnam

(Handwritten signature)

51	411515103058	Manivannan R	T. Mohan	T. Mohan	T. Mohan	T. Mohan	T. Mohan
52	411515103061	Mohan T	Mohan T	Mohan T	Mohan T	Mohan T	Mohan T
53	411515103062	Narendhiran G	Narendhiran G	Narendhiran G	Narendhiran G	Narendhiran G	Narendhiran G
54	411515103063	Nirmal Kumar P	P. Nirmal	P. Nirmal	P. Nirmal	P. Nirmal	P. Nirmal
55	411515103064	Nithish Raja N	Nithish Raja N	Nithish Raja N	Nithish Raja N	Nithish Raja N	Nithish Raja N
56	411515103066	Parthiban M	Parthiban M	Parthiban M	Parthiban M	Parthiban M	Parthiban M
57	411515103067	Pavithra D	Pavithra D	Pavithra D	Pavithra D	Pavithra D	Pavithra D
58	411515103068	Prabhu S	Prabhu S	Prabhu S	Prabhu S	Prabhu S	Prabhu S
59	411515103069	Praveen R	Praveen R	Praveen R	Praveen R	Praveen R	Praveen R
60	411515103070	Praveen Kumar C	Praveen Kumar C	Praveen Kumar C	Praveen Kumar C	Praveen Kumar C	Praveen Kumar C
61	411515103071	Pravin Ajho M	Pravin Ajho M	Pravin Ajho M	Pravin Ajho M	Pravin Ajho M	Pravin Ajho M
62	411515103072	Preethi K	Preethi K	Preethi K	Preethi K	Preethi K	Preethi K
63	411515103075	Ragul R	Ragul R	Ragul R	Ragul R	Ragul R	Ragul R
64	411515103076	Rammohan S	Rammohan S	Rammohan S	Rammohan S	Rammohan S	Rammohan S
65	411515103077	Ramu R	Ramu R	Ramu R	Ramu R	Ramu R	Ramu R
66	411515103078	Ramy Githanjali S	Ramy Githanjali S	Ramy Githanjali S	Ramy Githanjali S	Ramy Githanjali S	Ramy Githanjali S
67	411515103079	Ranjith Kumar N	Ranjith Kumar N	Ranjith Kumar N	Ranjith Kumar N	Ranjith Kumar N	Ranjith Kumar N
68	411515103080	Ranjith Kumar P	Ranjith Kumar P	Ranjith Kumar P	Ranjith Kumar P	Ranjith Kumar P	Ranjith Kumar P
69	411515103081	Rathna Gowtham R M	Rathna Gowtham R M	Rathna Gowtham R M	Rathna Gowtham R M	Rathna Gowtham R M	Rathna Gowtham R M
70	411515103082	Sasi Kumar R	Sasi Kumar R	Sasi Kumar R	Sasi Kumar R	Sasi Kumar R	Sasi Kumar R
71	411515103083	Sathish Pandian C	Sathish Pandian C	Sathish Pandian C	Sathish Pandian C	Sathish Pandian C	Sathish Pandian C
72	411515103084	Selva Ganesh K	Selva Ganesh K	Selva Ganesh K	Selva Ganesh K	Selva Ganesh K	Selva Ganesh K
73	411515103085	Sharvesh R	Sharvesh R	Sharvesh R	Sharvesh R	Sharvesh R	Sharvesh R
74	411515103086	Shre Shinika G	Shre Shinika G	Shre Shinika G	Shre Shinika G	Shre Shinika G	Shre Shinika G
75	411515103088	Sivasakthi R	Sivasakthi R	Sivasakthi R	Sivasakthi R	Sivasakthi R	Sivasakthi R
76	411515103089	Srihari S	Srihari S	Srihari S	Srihari S	Srihari S	Srihari S
77	411515103090	Sriram S	Sriram S	Sriram S	Sriram S	Sriram S	Sriram S
78	411515103091	Subashi D	Subashi D	Subashi D	Subashi D	Subashi D	Subashi D
79	411515103092	Subbulakshmi R	Subbulakshmi R	Subbulakshmi R	Subbulakshmi R	Subbulakshmi R	Subbulakshmi R
80	411515103093	Surya S	Surya S	Surya S	Surya S	Surya S	Surya S
81	411515103094	Thamizharasan R	Thamizharasan R	Thamizharasan R	Thamizharasan R	Thamizharasan R	Thamizharasan R
82	411515103095	Thangamuthu M	Thangamuthu M	Thangamuthu M	Thangamuthu M	Thangamuthu M	Thangamuthu M
83	411515103096	Tharvesh Mohaideen	Tharvesh Mohaideen	Tharvesh Mohaideen	Tharvesh Mohaideen	Tharvesh Mohaideen	Tharvesh Mohaideen
84	411515103097	Veeraselvan P	Veeraselvan P	Veeraselvan P	Veeraselvan P	Veeraselvan P	Veeraselvan P
85	411515103098	Vel Murugan V	Vel Murugan V	Vel Murugan V	Vel Murugan V	Vel Murugan V	Vel Murugan V
86	411515103099	Vidhya S	Vidhya S	Vidhya S	Vidhya S	Vidhya S	Vidhya S
87	411515103100	Vignesh M	Vignesh M	Vignesh M	Vignesh M	Vignesh M	Vignesh M
88	411515103101	Vigneshwaran M	Vigneshwaran M	Vigneshwaran M	Vigneshwaran M	Vigneshwaran M	Vigneshwaran M
89	411515103102	Vigneshwaran P	Vigneshwaran P	Vigneshwaran P	Vigneshwaran P	Vigneshwaran P	Vigneshwaran P
90	411515103103	Yakesh N	Yakesh N	Yakesh N	Yakesh N	Yakesh N	Yakesh N
91	411515103104	Yuvaraj D	Yuvaraj D	Yuvaraj D	Yuvaraj D	Yuvaraj D	Yuvaraj D
92	411515103105	Yuvaraj K	Yuvaraj K	Yuvaraj K	Yuvaraj K	Yuvaraj K	Yuvaraj K
93	411515103301	Ajithkumar M	Ajithkumar M	Ajithkumar M	Ajithkumar M	Ajithkumar M	Ajithkumar M
94	411515103302	Basilton Immanuel	Basilton Immanuel	Basilton Immanuel	Basilton Immanuel	Basilton Immanuel	Basilton Immanuel
95	411515103303	Bhavani S	Bhavani S	Bhavani S	Bhavani S	Bhavani S	Bhavani S
96	411515103304	K.Gokulnath	K.Gokulnath	K.Gokulnath	K.Gokulnath	K.Gokulnath	K.Gokulnath
97	411515103305	Karthick D	Karthick D	Karthick D	Karthick D	Karthick D	Karthick D
98	411515103306	Karthick M	Karthick M	Karthick M	Karthick M	Karthick M	Karthick M
99	411515103307	Priya M	Priya M	Priya M	Priya M	Priya M	Priya M
100	411515103308	Santhana Krishnan	Santhana Krishnan	Santhana Krishnan	Santhana Krishnan	Santhana Krishnan	Santhana Krishnan

Handwritten signature in green ink.

Handwritten signature in black ink.

Dr. R. PALSON KENNEDY, M.E., Ph.D.
 PRINCIPAL
 PERI INSTITUTE OF TECHNOLOGY
 Mannivakkam, Chennai - 600 048

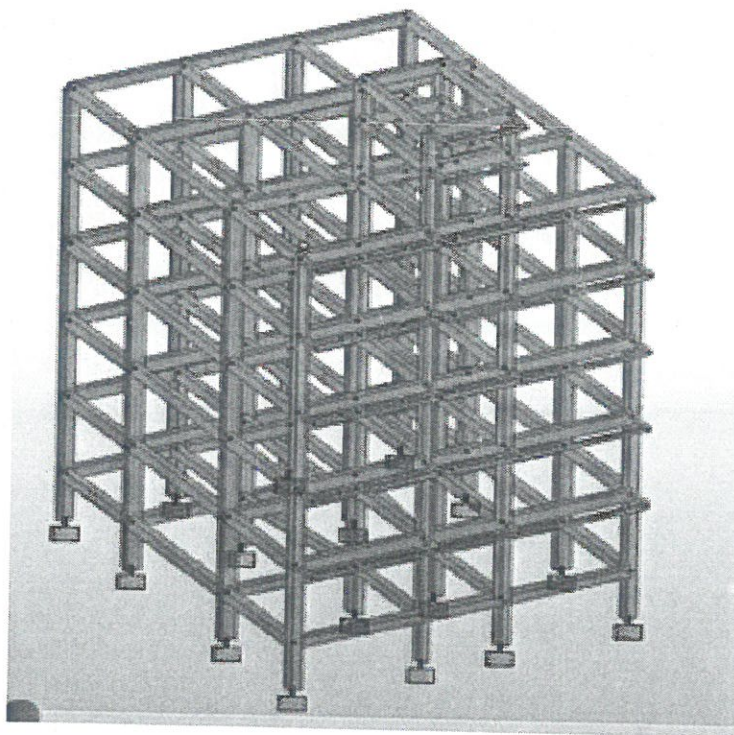
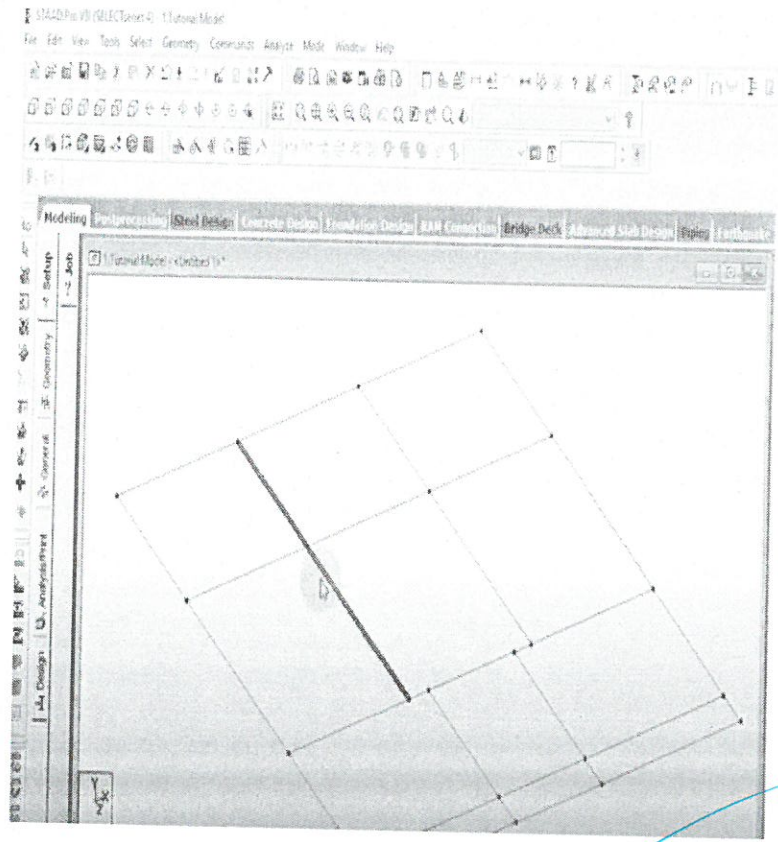

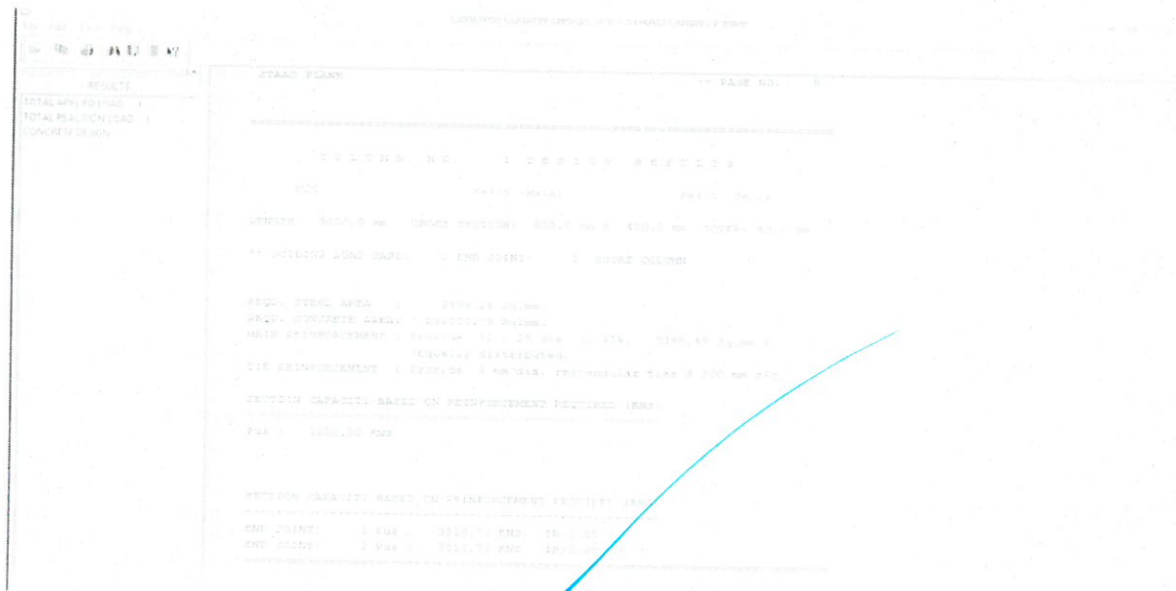
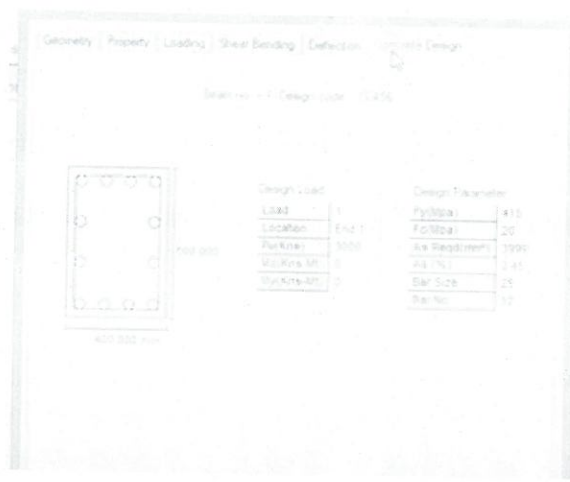

26
23

NAME	M.DINESH
REG. NO	411515103033
YEAR	IV
DEPT	CIVIL
COURSECODE/NAME	CC008-ANALYSIS OF STRUCTURE USING STAADPRO
TEST DATE	15/02/2019

15/2/19

PERI INSTITUTE OF TECHNOLOGY
DEPARTMENT OF CIVIL ENGINEERING
FEEDBACK FORM FOR VALUE ADDED COURSES

ACADEMIC YEAR 2018-2019

Name of the Course : CC008-Analysis of Structures using STAAD Pro

Name of the Student : M. BOOMIOTA - 411515103028

Year / Semester : IV / 8

- Brief about the course:

In this course structure was analysed using the software STAAD Pro. By applying various combinations.

- In what aspects the course content can be improved?

By giving the more practical sessions.

- Write down the benefits you got by attending this Course

The benefits of attending this course is now, I can able to analyse the steel structure.

- Does the course have brought any change in your understanding of the subject? Mention in detail.

Practical field knowledge is improved

- Is the course recommendable for the forth coming batch of the students?

Yes.

Signature of the student

PERI INSTITUTE OF TECHNOLOGY
DEPARTMENT OF CIVIL ENGINEERING
FEEDBACK FORM FOR VALUE ADDED COURSES

ACADEMIC YEAR 2018-2019

Name of the Course : CC008-Analysis of Structures using STAAD Pro

Name of the Student : M. DINESH - A11515103033

Year / Semester : IV / 08

- Brief about the course:

In this course structure was analysed using software STAAD Pro. By applying various load combinations.

- In what aspects the course content can be improved?

By giving more practical sessions.

- Write down the benefits you got by attending this Course

Now, I can able to analyse the steel structure.

- Does the course have brought any change in your understanding of the subject? Mention in detail.

Practical field knowledge improved.

- Is the course recommendable for the forth coming batch of the students?

Yes.

M. Dinesh

Signature of the student

PERI INSTITUTE OF TECHNOLOGY
DEPARTMENT OF CIVIL ENGINEERING
FEEDBACK FORM FOR VALUE ADDED COURSES

ACADEMIC YEAR 2018-2019

Name of the Course : CC008-Analysis of Structures using STAAD Pro

Name of the Student : S. AAKASH - 411515103009

Year / Semester : IV / 08

- Brief about the course:
In this course structure was analyse using the software STAAD Pro applying various load combinations.
- In what aspects the course content can be improved?
By giving more practical sections.
- Write down the benefits you got by attending this Course
Now, I can to analyse the steel structure
- Does the course have brought any change in your understanding of the subject?
Mention in detail.
practical field knowledge improved
- Is the course recommendable for the forth coming batch of the students?
Yes.

Ak

Signature of the student

PERI

INSTITUTE OF TECHNOLOGY

DEPARTMENT OF CIVIL ENGINEERING

Organizes

ADD ON COURSE IN

“CC008 - ANALYSIS OF STRUCTURES USING STAAD PRO”

CERTIFICATE
OF COMPLETION

This is to certify that Mr / Ms. S. AAKASH (4115151030018)

studying IV year in the Department of Civil Engineering has successfully completed the course on **CC008 - ANALYSIS OF STRUCTURES USING STAAD PRO** for the duration of **40** hours in the period from **11/02/2019** to **15/02/2019** during the Academic year **2018 - 2019**.



PRINCIPAL



VICE PRINCIPAL



HOD

PERI

INSTITUTE OF TECHNOLOGY

DEPARTMENT OF CIVIL ENGINEERING

Organizes

ADD ON COURSE IN

"CC008 - ANALYSIS OF STRUCTURES USING STAAD PRO"

CERTIFICATE
OF COMPLETION

This is to certify that Mr / Ms. N. BDOMICHA (411515103028)

studying IV year in the Department of Civil Engineering has successfully completed the course on **CC008 - ANALYSIS OF STRUCTURES USING STAAD PRO** for the duration of **40** hours in the period from **11/02/2019** to **15/02/2019** during the Academic year **2018 - 2019**.



PRINCIPAL



VICE PRINCIPAL



HOD

www.peri.education

PERI Knowledge Park, Mannivakkam, Chennai - 600048

PERI

INSTITUTE OF TECHNOLOGY

DEPARTMENT OF CIVIL ENGINEERING

Organizes

ADD ON COURSE IN

"CC008 - ANALYSIS OF STRUCTURES USING STAAD PRO"

CERTIFICATE
OF COMPLETION

This is to certify that Mr / Ms. M. DINESH (411515103033)

studying IV year in the Department of Civil Engineering has successfully completed the course on **CC008 - ANALYSIS OF STRUCTURES USING STAAD PRO** for the duration of **40** hours in the period from **11/02/2019** to **15/02/2019** during the Academic year **2018 - 2019**.



PRINCIPAL



VICE PRINCIPAL



HOD

www.peri.education

PERI Knowledge Park, Mannivakkam, Chennai - 600048

30.01.2019

Chennai

From

The HOD-CIVIL,
Peri Institute of Technology
Mannivakkam,
Chennai-48

To

The Principal
PERI Institute of Technology
Chennai

Sir,

Sub: Approval to conduct a program on "CC09 -Workshop on Building Drawing – Reg

The department of Civil Engineering is planning to conduct a program titled "CC09 -
Workshop on Building Drawing" training for II year Civil Engineering students. Kindly
accord permission for conducting the program.

S.No.	Year	Scheduled Date	Time
1	II	11-02-2019 to 14-02-2019	8.30a.m to 3.40p.m

Thanking You

Yours Truly



Head of the Department
Department of Civil Engineering
Peri Institute of Technology,
Mannivakkam, Chennai - 600 048

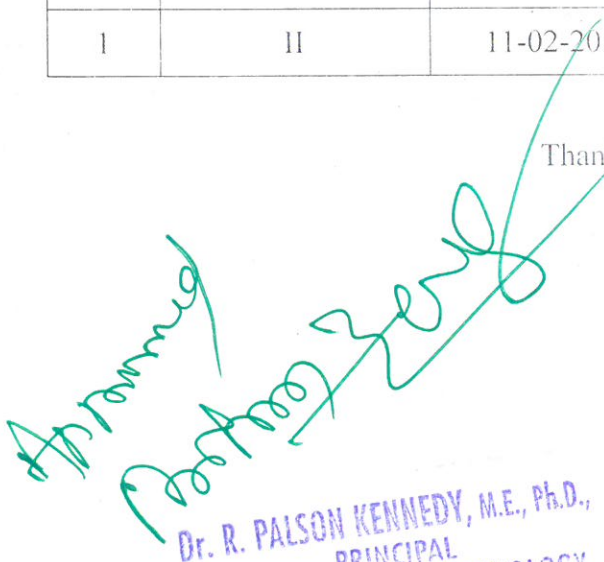

Dr. R. PALSON KENNEDY, M.E., Ph.D.,
PRINCIPAL
PERI INSTITUTE OF TECHNOLOGY
Mannivakkam, Chennai - 600 048.

PERI

INSTITUTE OF TECHNOLOGY

Mannivakkam, Chennai 600048

DEPARTMENT OF CIVIL ENGINEERING

ACADEMIC YEAR 2018-2019

PERIIT /CIVIL/Add on Course /2018-2019/Even/02

Date: 01.02.2019

CIRCULAR

Department of Civil Engineering is planned to conduct a program titled “CC09 -Workshop on Building Drawing” for the Academic Year 2018 – 2019 for CIVIL Engineering II year students directed to attend the program.

S.No.	Year	Scheduled Date	session
1	II	11-02-2019 to 14-02-2019	8.30a.m to 3.40p.m

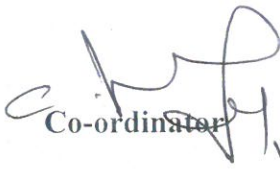
Co-ordinator
1,12/19

Head of the Department

Head of the Department
Department of Civil Engineering
PERI Institute of Technology,
Mannivakkam, Chennai - 600 048.

Copy To:

1. Principal
2. Vice – Principal
3. IQAC
4. Faculty Members – Civil
5. Main – Notice Board

PERI INSTITUTE OF TECHNOLOGY
DEPARTMENT OF CIVIL ENGINEERING

ACADEMIC YEAR 2018-2019

ADD ON COURSE-CC09 -Workshop on Building Drawing

Minutes of the Meeting held on 05.02.2019

Venue : HOD Room, Civil Department, Beta Block,
PERI Institute of Technology

Date : 05.02.2019

Time : 1:30pm – 3:30pm

Agenda of the Meeting:

1. Syllabus preparation
2. Tentative Timetable preparation
3. Assessment method discussion

Members Present:

1. Mr. B. Magesh, Head of the Department, Civil Engineering
2. Ms. C. Lavanya, VAC Coordinator, Civil Engineering
- 3 Mr. K.Rajaraman , Industrial Expert, Shoba Developers,Bangalore

Ms. C. Lavanya, VAC Coordinator welcomed and briefed the consultative committee members about the meeting. The guidelines prescribed for Value Added Courses by Anna University are disseminated to the consultative committee members.

Agenda Item 1: Syllabus preparation

The syllabus is framed in accordance with the view to achieve the desired outcomes of the course. The courses similar to the selected course in the curriculum of UG and PG programmes offered by various IITs, NITs, Anna University and other Universities has been analysed and final syllabus is framed by the consultative committee members.

Agenda Item 2: Tentative Timetable preparation

The Timetable for Add on Course classes and Internal Assessment is prepared based on guidelines prescribed by Anna University. Total of 30 periods with 32 hours on Saturdays is decided and communicated to the Course faculty.

Agenda Item 3: Assessment method

Internal assessments to be conducted only at the end of the course is decided. Internal Assessment is decided to be conducted for Autocadd Plan

Part A – Auto-cadd Plan – 1*30 = 30 marks

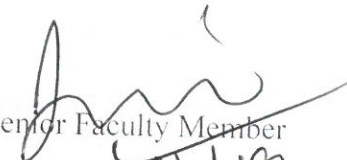

Coordinator
5/2/19

Senior Faculty Member
5/2/19

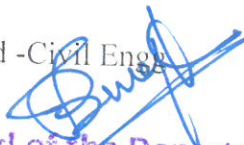
Industry Expert
5/2/19

Hod - Civil Engg

Head of the Department
Department of Civil Engineering
PERI Institute of Technology,
Mannivakkam, Chennai - 600 048

Principal

Dr. R. PALSON KENNEDY, M.E., Ph.D.,
PRINCIPAL
PERI INSTITUTE OF TECHNOLOGY
Mannivakkam, Chennai - 600 048.

DEPARTMENT OF CIVIL ENGINEERING

ACADEMIC YEAR 2018-2019

ADD ON COURSE-SYLLABUS

CC009-Workshop on Building Drawing

Module 1

Need for Designing □ Introduction to CAD/CAM/CAE □ Concept of Designing and Drafting □ Angle of projections □ First angle projection .Third angle projection ,Orthographic and Isometric views , Quadrants □ Basic Drafting rules Introduction to AutoCAD □ Introduction to Autocad.COORDINATE SYSTEMS .AUTOCAD BASICS.Polyline edit (PEdit).Array (AR) □ Rectangular Array (ARRAYRECT).Properties (PR) □ Line properties □ Match properties

Module 2

Multiline Edit (MLEDIT) , Cutting and Welding Multiple.Spline (SPL),Stretch (S) □ Lengthen (LEN),Block (B) .Block (B) □ Base point □ Object □ Behavior □ Insert block (I) Intersection point □ Scale □ Rotation,□ Write block (W) □ Base point □ Object □ Trim (TR) □ Fence (F).Arc Length (DAR) □ Dimension Break (DIMBREAK),□ Diameter Dimension (DDI) □ M text (M) Text (T) □ Angle (A) □ Radius Dimension (DRA) □ M text (M) □ Text (T) □ Angle (A) Joggled Dimension (DJO) □ M text (M) □ Text (T) □ Angle (A) □ Ordinate Dimension (DOR) □ X datum (X) □ Y datum (Y),M text (M) , Text (T) ,Angle (A)

Module 3

□
Dimension Break (DIMBREAK) □ Auto (A) □ Manual (M) □ Remove (R) □ Multiple (M) □ Dimension Space (DIMSPACE) □ Value (Default) □ Auto (A).Plan Creation □ Area □ Object (O) □ Add Area (A) □ Subtract Area (S) □ AutoCAD Design Center (ADC) □ Tool Palettes (TP) Basic room Dimensions □ Basic Furniture Dimensions.Elevation □ Section Detailing □ Hatch (H) □ Gradient(GD/GRA) □ Boundary(BO) .Text (DT).Justify (J) ,Mtext (MTED),Table Edit ,Layout (LO) □ Layout wizard □ Multi view (MVIEW) □ View ports (VPORTS) Viewport maximum (VPMAX) □ Viewport minimum (VPMIN) □ LAYVPI □ Model space (MS) □ Paper space (PS) □ Model,Tilemode (TI),Attributes (ATT) External reference (XR) □ Page Setup Manager □ Plot (Ctrl+P)Sheet set(SSM).Export(EXP) Options (OP) .Image(IM) □ Imageadjust □ Imageattach Imageclip □ Imagequality □ Imageframe □ Title block creation .Basic Autocadd plan

Module 4

Isometric views □ Isoplane change □ Ellipse(EL) .Isocircle. Isometric practice,3D-MODELING □ Introduction to AutoCAD 3d □ Starting three dimensional modelling in AutoCAD □ Use of three dimensional drawing □ Types of 3d models □.Creating Solid Models □ Polysolid □ Box □ Wedge □ Cone □ Sphere . Cylinder . Torus □ Pyramid . Helix □ Presspull □ Sweep □ Revolve □ Loft.3D Operations .CS icon □ Dynamic UCS □ Viewport □ Creating 3D Models (practice session).Material browser □ Assigning materials □ Assigning selected materials to object □ Basic rendering □ Creating new materials Default light □ Point light Spot light □ Distance light,□ Camera □ Walkthrough □ Motion recorder □ Import□

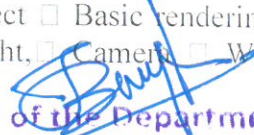
Head of the Department
Department of Civil Engineering
PERI Institute of Technology,
Mannivakkam, Chennai - 600 076

DEPARTMENT OF CIVIL ENGINEERING

ACADEMIC YEAR 2018-2019

ADD ON COURSE-TIME TABLE

CC009-Workshop on Building Drawing

S.No	Date	Hours	Topics
1	11.02.2019	1-8	Need for Designing ☐ Introduction to CAD/CAM/CAE ☐ Concept of Designing and Drafting ☐ Angle of projections ☐ First angle projection ,Third angle projection ,Orthographic and Isometric views , Quadrants ☐ Basic Drafting rules Introduction to AutoCAD ☐ Introduction to Autocad.COORDINATE SYSTEMS ,AUTOCAD BASICS.Polyline edit (PEdit).Array (AR) ☐ Rectangular Array (ARRAYRECT).Properties (PR) ☐ Line properties ☐ Match properties
2	12.02.2019	1-8	Multiline Edit (MLEEDIT) , Cutting and Welding Multiple.Spline (SPL).Stretch (S) ☐ Lengthen (LEN),Block (B) ,Block (B) ☐ Base point ☐ Object ☐ Behavior ☐ Insert block (I) Intersection point ☐ Scale ☐ Rotation.☐ Write block (W) ☐ Base point ☐ Object ☐ Trim (TR) ☐ Fence (F).Arc Length (DAR) ☐ Dimension Break (DIMBREAK),☐ Diameter Dimension (DDI) ☐ M text (M) Text (T) ☐ Angle (A) ☐ Radius Dimension (DRA) ☐ M text (M) ☐ Text (T) ☐ Angle (A) Jogged Dimension (DJO) ☐ M text (M) ☐ Text (T) ☐ Angle (A) ☐ Ordinate Dimension (DOR) ☐ X datum (X) ☐ Y datum (Y),M text (M) , Text (T) ,Angle (A)
3	13.02.2019	1-8	Dimension Break (DIMBREAK) ☐ Auto (A) ☐ Manual (M) ☐ Remove (R) ☐ Multiple (M) ☐ Dimension Space (DIMSPACE) ☐ Value (Default) ☐ Auto (A).Plan Creation ☐ Area ☐ Object (O) ☐ Add Area (A) ☐ Subtract Area (S) ☐ AutoCAD Design Center (ADC) ☐ Tool Palettes (TP) Basic room Dimensions ☐ Basic Furniture Dimensions,Elevation ☐ Section Detailing ☐ Hatch (H) ☐ Gradient(GD/GRA) ☐ Boundary(BO) .Text (DT)Justify (J) .Medit (MTED).Table Edit ,Layout (LO) ☐ Layout wizard ☐ Multi view (MVIEW) ☐ View ports (VPORTS) Viewport maximum (VPMAX) ☐ Viewport minimum (VPMIN) ☐ LAYVPI ☐ Model space (MS) ☐ Paper space (PS) ☐ Model,Tilemode (TI),Attributes (ATT) External reference (XR) ☐ Page Setup Manager ☐ Plot (Ctrl+P)Sheet set(SSM).Export(EXP) Options (OP) ,Image(IM) ☐ Imageadjust ☐ Imageattach Imageclip ☐ Imagequality ☐ Imageframe ☐ Title block creation ,Basic AutoCAD plan
4	14.02.2019	1-8	Isometric views ☐ Isoplane change ☐ Ellipse(EL) ,Isocircle, Isometric practice.3D-MODELING ☐ Introduction to AutoCAD 3d ☐ Starting three dimensional modelling in AutoCAD ☐ Use of three dimensional drawing ☐ Types of 3d models ☐ Creating Solid Models ☐ Polysolid ☐ Box ☐ Wedge ☐ Cone ☐ Sphere , Cylinder , Torus ☐ Pyramid , Helix ☐ Presspull ☐ Sweep ☐ Revolve ☐ Loft.3D Operations ,CS icon ☐ Dynamic UCS ☐ Viewport ☐ Creating 3D Models (practice session).Material browser ☐

			Assigning materials <input type="checkbox"/> Assigning selected materials to object <input type="checkbox"/> Basic rendering <input type="checkbox"/> Creating new materials Default light <input type="checkbox"/> Point light Spot light <input type="checkbox"/> Distance light, <input type="checkbox"/> Camera <input type="checkbox"/> Walkthrough <input type="checkbox"/> Motion recorder <input type="checkbox"/> Import <input type="checkbox"/>
--	--	--	--

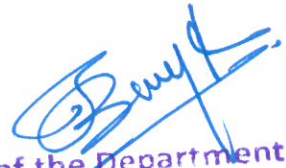

Head of the Department
Department of Civil Engineering
PERI Institute of Technology,
Mannivakkam, Chennai - 600 048

DEPARTMENT OF CIVIL ENGINEERING

ACADEMIC YEAR 2018-2019

ADD ON COURSE

CC009 Workshop on Building Drawing

STUDENTS LIST

Second Years		
1	411517103001	K. Ajeeth Kumar
2	411517103002	A. AllampatiBhaskar
3	411517103003	J. Anthony Bala
4	411517103004	R. Arun
5	411517103006	P. Balamurugan
6	411517103007	V. Bojarajan
7	411517103009	V. Dhanraj
8	411517103011	C. Manikandan
9	411517103013	M. Manoj Kumar
10	411517103014	S. Masimalai
11	411517103015	S. Mohamed Yasin
12	411517103016	P. Naresh
13	411517103018	K. Pravin
14	411517103019	J. Preveen
15	411517103020	P. Sakthivel
16	411517103021	S. SathyaPriya
17	411517103022	A. Shruthi
18	411517103023	A. Shwetha

19	411517103024	K. Thamizharasan
20	411517103025	G. Vasanth
21	411517103026	M. Vijai Mohan
22	411517103301	D. Ajith Kumar
23	411517103302	P. Dhamodaran
24	411517103303	N. JashwanthNagaraj
25	411517103305	J.M. JervinRebaario
26	411517103306	G. Santhosh Kumar

e. h. j.

DEPARTMENT OF CIVIL ENGINEERING

ADD ON COURSE

Workshop on Building Drawing- CC009

ACADEMIC YEAR 2018- 2019

ATTENDANCE SHEET

11.02.2019 to 14.02.2019

Duration of course:32 Hours

Number of students enrolled in the year:26

Second Years

S. No.	Reg. No.	Name of the Students	11.02.2019	12.02.2019	13.02.2019	14.02.2019
1	411517103001	K. Ajeeth Kumar	Ajeeth	Ajeeth	Ajeeth	Ajeeth
2	411517103002	A. AllampatiBhaskar	Bhaskar	Bhaskar	Bhaskar	Bhaskar
3	411517103003	J. Anthony Bala	Bala	Bala	Bala	Bala
4	411517103004	R. Arun	R. ARUN	R. ARUN	R. ARUN	R. ARUN
5	411517103006	P. Balamurugan	Bala	Bala	Bala	Bala
6	411517103007	V. Bojarajan	Bojan	Bojan	Bojan	Bojan
7	411517103009	V. Dhanraj	Dhanraj	Dhanraj	Dhanraj	Dhanraj
8	411517103010	J. Jayasree	Jayasree	Jayasree	Jayasree	Jayasree
9	411517103011	C. Manikandan	mani	mani	mani	mani
10	411517103013	M. Manoj Kumar	M. Manoj	M. Manoj	M. Manoj	M. Manoj
11	411517103014	S. Masimalai	masi	masi	masi	masi
12	411517103015	S. Mohamed Yasin	Yasin	Yasin	Yasin	Yasin
13	411517103016	P. Naresh	naresh	naresh	naresh	naresh
14	411517103018	K. Pravin	K. Pravin	K. Pravin	K. Pravin	K. Pravin
15	411517103019	J. Preveen	Preveen	Preveen	Preveen	Preveen
16	411517103020	P. Sakthivel	Sakthivel	Sakthivel	Sakthivel	Sakthivel
17	411517103021	S. SathyaPriya	Sathya	Sathya	Sathya	Sathya
18	411517103022	A. Shruthi	A. Shruthi	A. Shruthi	A. Shruthi	A. Shruthi
19	411517103023	A. Shwetha	Shwetha	Shwetha	Shwetha	Shwetha
20	411517103024	K. Thamizharasan	Thamizharasan	Thamizharasan	Thamizharasan	Thamizharasan
21	411517103025	G. Vasanth	Vasanth	Vasanth	Vasanth	Vasanth
22	411517103026	M. Vijai Mohan	Vijai	Vijai	Vijai	Vijai
23	411517103301	D. Ajith Kumar	Ajith Kumar	Ajith Kumar	Ajith Kumar	Ajith Kumar
24	411517103302	P. Dhamodaran	Dhamo	Dhamo	Dhamo	Dhamo
25	411517103303	N. JashwanthNagaraj	Jashwanth	Jashwanth	Jashwanth	Jashwanth
26	411517103305	J.M. JervinRebaario	Jervin	Jervin	Jervin	Jervin
27	411517103306	G. Santhosh Kumar	Santhosh	Santhosh	Santhosh	Santhosh

(Handwritten signature in green ink)

(Handwritten signature in blue ink)

Dr. R. PALSON KENNEDY, M.E., Ph.D.
PRINCIPAL

PERI INSTITUTE OF TECHNOLOGY
Mannivakkam, Chennai - 600 048

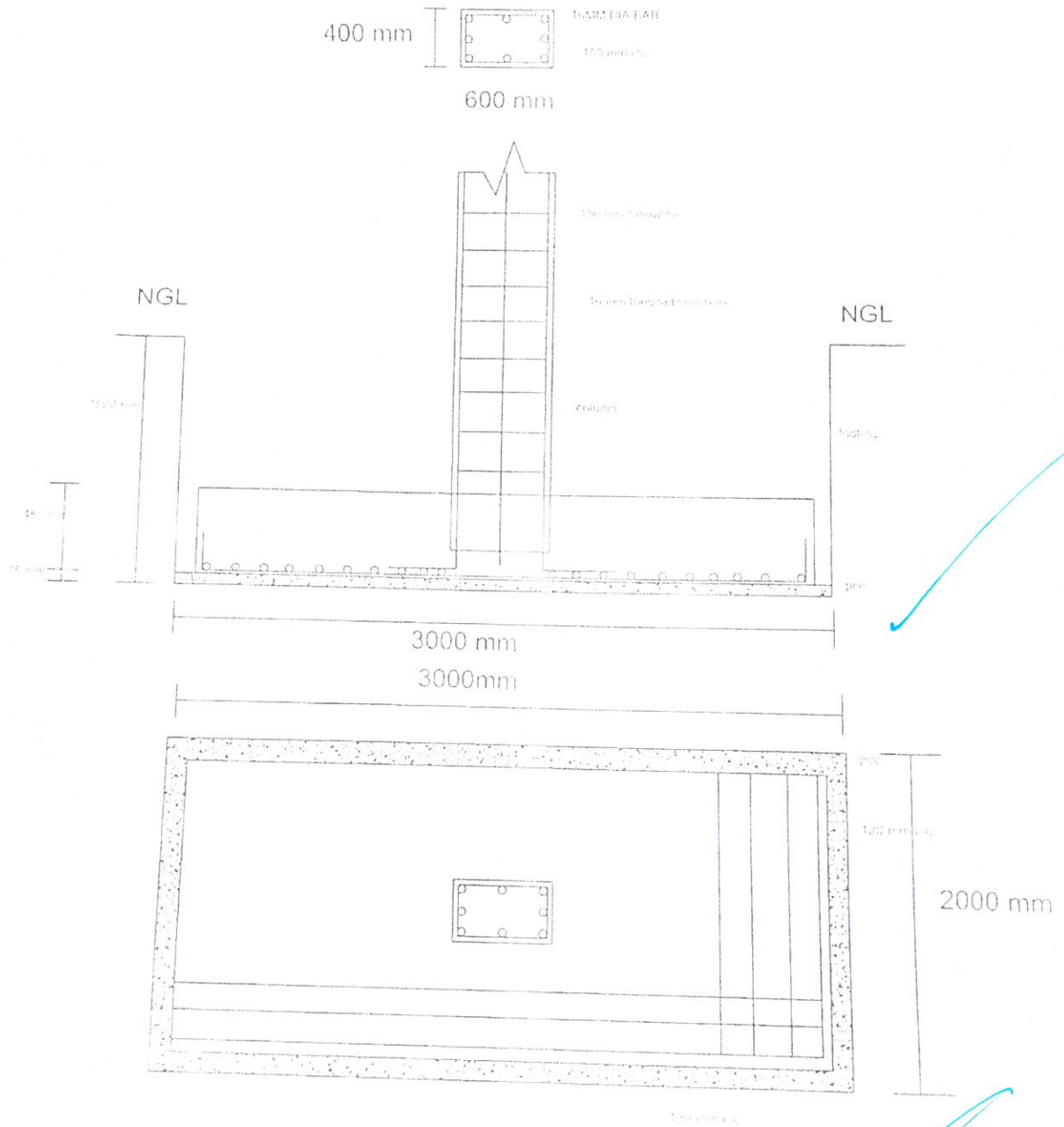

14/02/19 28/30

NAME	V.DHANRAJ
REG. NO	411517103009
YEAR	II
DEPT	CIVIL
COURSE CODE/NAME	CC009-WORKSHOP ON BUILDING DRAWING
TEST DATE	14.02.2019

27/30
14/02/19

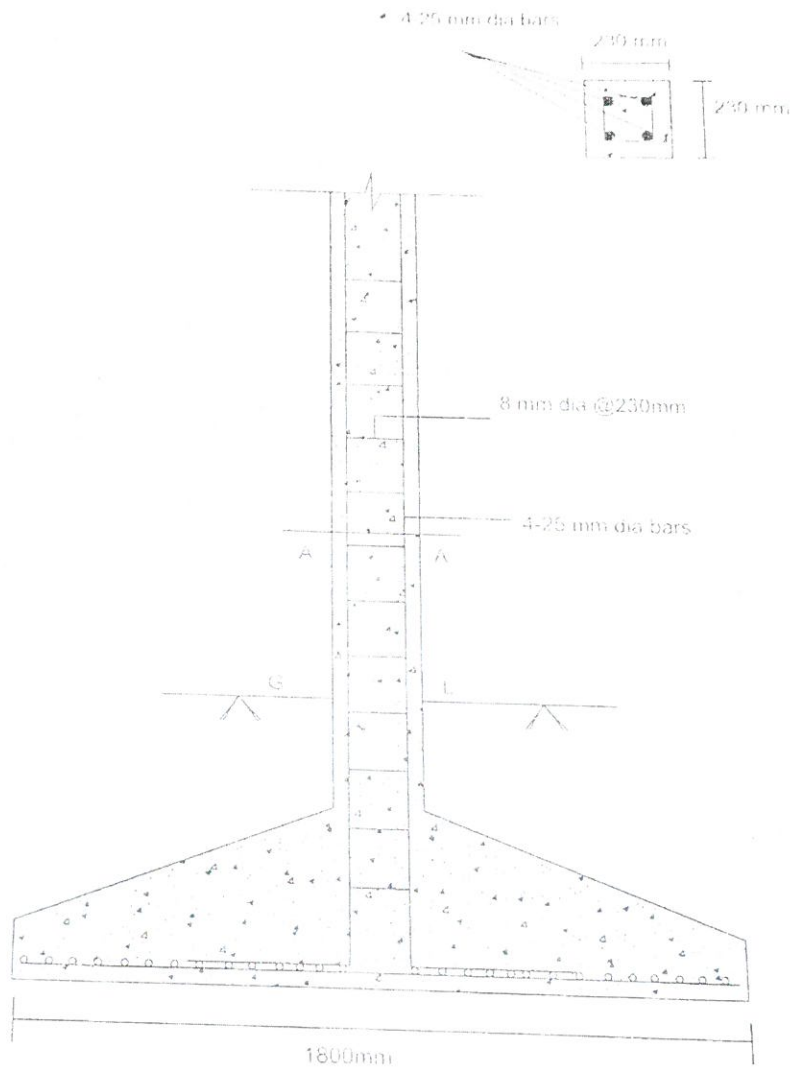

NAME	S. MASILAMANI
REG. NO	411517103014
YEAR	II
DEPT	CIVIL
COURSE CODE/NAME	CC009-WORKSHOP ON BUILDING DRAWING
TEST DATE	14.02.2019

PERI INSTITUTE OF TECHNOLOGY
DEPARTMENT OF CIVIL ENGINEERING
FEEDBACK FORM FOR VALUE ADDED COURSES

ACADEMIC YEAR 2018-2019

Name of the Course : CC009-Workshop on Building Drawing

Name of the Student : V. DHANRAJ - 11517103009

Year / Semester : II / 04

- Brief about the course:

Basic Autocad knowledge had been taught

- In what aspects the course content can be improved?

By providing more exercise on plan 20.

- Write down the benefits you got by attending this Course

I can plan for my own house

- Does the course have brought any change in your understanding of the subject?
Mention in detail.

In depth knowledge about the AUTOCAD tools
for building drawing

- Is the course recommendable for the forth coming batch of the students?

Yes.

V. Dhanraj
11/21/19
Signature of the student

PERI INSTITUTE OF TECHNOLOGY
DEPARTMENT OF CIVIL ENGINEERING
FEEDBACK FORM FOR VALUE ADDED COURSES

ACADEMIC YEAR 2018-2019

Name of the Course : CC009-Workshop on Building Drawing
Name of the Student : S. MASIMALAI - 411517103014
Year / Semester : 11 - IV

- Brief about the course:

Basic Autocad knowledge had been taught

- In what aspects the course content can be improved?

By providing more exercise on plan. 2D.

- Write down the benefits you got by attending this Course

I can plan for my own house.

- Does the course have brought any change in your understanding of the subject?
Mention in detail.

In depth knowledge about the Autocad tools for building drawing.

- Is the course recommendable for the forth coming batch of the students?

Yes.

S. Masimalai

Signature of the student

PERI INSTITUTE OF TECHNOLOGY
DEPARTMENT OF CIVIL ENGINEERING
FEEDBACK FORM FOR VALUE ADDED COURSES

ACADEMIC YEAR 2018-2019

Name of the Course : CC009-Workshop on Building Drawing

Name of the Student : S. SATHYA PRIYA

Year / Semester : II / 04

- Brief about the course:

Basic AutoCAD knowledge had been taught.

- In what aspects the course content can be improved?

By providing the more exercise on the plan & in 2D.

- Write down the benefits you got by attending this Course

I can plan for my own company and house.

- Does the course have brought any change in your understanding of the subject?
Mention in detail.

In depth knowledge about the AutoCAD tools for the building drawing.

- Is the course recommendable for the forth coming batch of the students?

yes, i can recommend it.

SATHYA PRIYA
Signature of the student

PERI

INSTITUTE OF TECHNOLOGY

DEPARTMENT OF CIVIL ENGINEERING

Organizes

ADD ON COURSE IN

“CC009 - WORKSHOP ON BUILDING DRAWING”

CERTIFICATE

OF COMPLETION

This is to certify that Mr / Ms. V. DHANRAJ (411517103009)

studying 11nd year in the Department of Civil Engineering has successfully completed the

course on **CC009 - WORKSHOP ON BUILDING DRAWING** for the duration of **32** hours

in the period from **11/02/2019** to **14/02/2019** during the Academic year **2018 - 2019**.



PRINCIPAL



VICE PRINCIPAL



HOD

www.peri.education

PERI Knowledge Park, Mannivakkam, Chennai - 600048

PERI

INSTITUTE OF TECHNOLOGY

DEPARTMENT OF CIVIL ENGINEERING

Organizes

ADD ON COURSE IN

“CC009 - WORKSHOP ON BUILDING DRAWING”

CERTIFICATE
OF COMPLETION

This is to certify that Mr / Ms. S. MASIMALAI (411517103014)

studying 11nd year in the Department of Civil Engineering has successfully completed the course on **CC009 - WORKSHOP ON BUILDING DRAWING** for the duration of **32** hours in the period from **11/02/2019** to **14/02/2019** during the Academic year **2018 - 2019**.



PRINCIPAL



VICE PRINCIPAL



HOD

PERI

INSTITUTE OF TECHNOLOGY

DEPARTMENT OF CIVIL ENGINEERING

Organizes

ADD ON COURSE IN

“CC009 - WORKSHOP ON BUILDING DRAWING”

CERTIFICATE
OF COMPLETION

This is to certify that Mr / Ms. S. SATHYA PRIYA (411517103021)

studying 11th year in the Department of Civil Engineering has successfully completed the

course on **CC009 - WORKSHOP ON BUILDING DRAWING** for the duration of **32** hours

in the period from **11/02/2019** to **14/02/2019** during the Academic year **2018 - 2019**.



PRINCIPAL



VICE PRINCIPAL



HOD

PERI

INSTITUTE OF TECHNOLOGY

Mannivakkam, Chennai 600048

DEPARTMENT OF COMPUTER SCIENCE AND ENGINEERING

ACADEMIC YEAR 2018-2019

Ref: PERIIT /CSE/CC/2018-2019/04

DATE: 07-07-2018

CIRCULAR

All the Students are hereby informed that Our College is going to organize ten days in Training in "Java Programming". The intension of this training is that our students should enhance the ability to manage interviews and improve their Skills .So all students are invited to attend this Event.

RESOURCE PERSON : Mr.V.G.Shanmugam,Technical Trainee.
Shan software solutions, Chennai

DATE : 16-07-2018 TO 20-07-2018
23-07-2018 TO 27-07-2018

TIME : 8.30 AM – 3.30 PM

VENUE : CONFERENCE HALL

Devathi.A
7/7/18
Coordinator

[Signature]
Head of the Department

Copy To:

1. Principal
2. Vice – Principal
3. IQAC
4. Faculty Members – CSE Staffs
5. Main – Notice Board

PERI INSTITUTE OF TECHNOLOGY

Mannivakkam, Chennai 600048

DEPARTMENT OF COMPUTER SCIENCE AND ENGINEERING

ACADEMIC YEAR 2018-2019

Minutes of the Meeting

Course name: Add-On Course- JAVA Programming

Venue: CSE HOD Room, Beta Block ,PERI IT

Date:08/07/2018 Time:10:00 AM-10:15AM

Agenda of the meeting:

1. Syllabus preparation
2. Tentative Time Table
3. Assessment method

Members present:

1. Dr.K.Varalakshmi,HOD/CSE
2. Mr Mohan Palaniswamy PROJECT TEAM LEADER , PERI SOFTWARE SOLUTIONS
3. Mrs A.Revathi, AP/CSE
4. Mrs Lena Bharathi ,AP/CSE

The meeting commenced with, the Coordinator Mrs A.Revathi, welcoming all the committee members and outlining the agenda for discussion.

Agenda Item 1:Syllabus preparation

She briefed the committee about the need to develop a syllabus for the "Java programming" workshop. She emphasized explained how it align with the course objectives and considers syllabi from various reputable institutions.

Agenda Item 2: Tentative Time Table

The committee reviewed the a well-structured timetable for the workshop. Mrs A.Revathi informed the members that the timetable should adhere to the requirements set forth by the university. The subject expert has been notified about the tentative timetable to ensure its feasibility.

Agenda Item 3: Assessment method

Assessments would be conducted at the end of the course to evaluate the participants

Coordinator

Senior faculty member

HOD/CSE

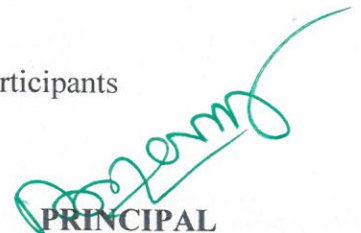
PRINCIPAL

Dr. R. PALSON KENNEDY, M.E., Ph.D.
PRINCIPAL
PERI INSTITUTE OF TECHNOLOGY
Mannivakkam, Chennai - 600 048

PERI INSTITUTE OF TECHNOLOGY

Mannivakkam, Chennai 600048

DEPARTMENT OF COMPUTER SCIENCE AND ENGINEERING

ACADEMIC YEAR 2018-2019

Course Code: CS018

Course Name: JAVA Programming

This course aims to provide you with the essential skills and knowledge to launch your career in software development using the Java programming language. This course curriculum encompasses fundamental concepts, object-oriented programming principles, and advanced topics, ensuring a thorough understanding of Java and its extensive ecosystem.

COURSE OBJECTIVES

- To Understand the Understand the Java Virtual Machine (JVM).
- To Familiarize with Object-Oriented Programming (OOP) Concepts.
- To Learn how to work with Arrays:
- To learn to develop Graphical User Interfaces(GUI).
- To Provide knowledge about Networking basics and to manage synchronization:

EVENT SCHEDULE

COMPANY	EVENT	DATE & TIME
SHAN SOFTWARE SERVICES	JAVA PROGRAMMING	16-07-2018 TO 20-07-2018 23-07-2018 TO 27-07-2018 8.30 AM TO 3.30 PM VENUE : PERIIT CONFERENCE HALL
Participation	IV YEAR CSE STUDENTS	

HOD/CSE

PERI INSTITUTE OF TECHNOLOGY

Mannivakkam-48

Department of Computer Science and Engineering

TIME TABLE

Course Code: CS0198

Year:IV YEAR CSE

Course Name:JAVA Programming

Session: FN &AN

Particulars	Session	Topic covered
DATE : 16-07-2018 TO 20-07-2018 23-07-2018 TO 27-07-2018 TIME : 8.30 AM – 3.30 PM VENUE: CONFERENCE HALL	FN & AN	Introduction to Java programming, The Java Virtual Machine, Variables and data types, Conditional and looping constructs, Arrays.
	FN & AN	Object-oriented programming with Java Classes and Objects, Fields and Methods, Constructors, Overloading methods, Garbage collection, Nested classes.
	FN & AN	Inheritance, Overriding methods, Polymorphism, Making methods and classes final, Abstract classes and methods, Interfaces. Exception handling with try-throw-catch-finally constructs, The Exception class, The Object class, Cloning objects
	FN & AN	Working with types: Wrapper classes, Enumeration interface. Packages, Package access, Documentation comments. Applets, Configuring applets, Applet capabilities and restrictions- Basics of AWT and Swing, LayoutManagers, EventHandling, The ActionListener interface, Panels, Classes for various controls
	FN & AN	Threads, Synchronization The I/O Package, InputStream and OutputStream classes, Reader and Writer classes, Basic concepts of networking, Working with URLs, Concepts

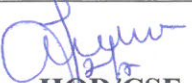
HOD/CSE

PERI INSTITUTE OF TECHNOLOGY

Mannivakkam, Chennai 600048

DEPARTMENT OF COMPUTER SCIENCE AND ENGINEERING

ACADEMIC YEAR 2018-2019

SYLLABUS

MODULE 1: INTRODUCTION TO JAVA PROGRAMMING

Introduction to Java programming-The Java Virtual Machine-Variables and data types-Conditional and looping constructs-Arrays.

MODULE II: OBJECT-ORIENTED PROGRAMMING WITH JAVA

Object-oriented programming with Java Classes and Objects-Fields and Methods-Constructors-Overloading methods-Garbagecollection-Nested classes.

MODULE III: ADVANCED JAVA CONCEPTS

Inheritance-Overriding methods-Polymorphism-Making methods and classes final-Abstract classes and methods-Interfaces. Exception handling with try-throw-catch-finally constructs-The Exception class-The Object class-Cloning objects

MODULE IV: JAVA ADVANCED FEATURES

Working with types: Wrapper classes,Enumeration interface.-Packages:Package access.Documentation comments. Applets: Configuring applets, Applet capabilities and restrictions- Basics of AWT and Swing-Layout Managers-Event Handling- The Action Listener interface-Panels-Classes for various controls

MODULE V : JAVA MULTITHREADING, I/O, AND NETWORKING ESSENTIALS

Threads-Synchronization-The I/O Package-Input Stream and Output Stream classes-Reader and Writer classes- Basic concepts of networking-Working with URLs-Concepts

Coordinator

HOD/CSE



Mannivakkam, Chennai 600048

DEPARTMENT OF COMPUTER SCIENCE AND ENGINEERING

ACADEMIC YEAR 2018-2019

Students Name List for JAVA programming(16-07-2018 TO 20-07-2018&23-07-2018 TO 27-07-2018)

S..No.	Register Number	Name of the Student
1.	411515104001	ABILA
2.	411515104002	ADARSH R
3.	411515104003	AJAY SURVE C
4.	411515104007	ANGELINE T
5.	411515104010	ARUNA A
6.	411515104012	BALAYOGASHREE G
7.	411515104014	DEEPAK K
8.	411515104015	DEVARAJAN E
9.	411515104016	DHARMESH M
10.	411515104018	DHEEPIKA R
11.	411515104022	GALI MADHAN KUMAR
12.	411515104024	GEETHANJALI V
13.	411515104026	HARISH V
14.	411515104027	JASMINE A
15.	411515104028	JOHN BETSON J

16.	411515104029	JOSEPH NAVEEN KUMAR S
17.	411515104031	KARTHIKEYAN B
18.	411515104032	KARTHIK RAJA V
19.	411515104035	KEERTHIKA S
20.	411515104036	KEIRON PRANAB T
21.	411515104037	KOWSALYA R
22.	411515104038	KOWSALYA V
23.	411515104041	LIPIYAN K
24.	411515104045	MADHUMITHA V
25.	411515104046	MAHESWARI M
26.	411515104047	MANIKANDAN V
27.	411515104049	MOHAMED ANSARI R
28.	411515104050	MOHAN K
29.	411515104052	MONIKA P M
30.	411515104054	SHASHANKA KOUSTUBH
31.	411515104057	PAVITHRA B
32.	411515104058	PAVITHRA R
33.	411515104059	PRADHAKSHNA B
34.	411515104060	PRAKASH C
35.	411515104061	PRASANTH P
36.	411515104065	PREETHI T
37.	411515104066	PREM VIGNESH R

38.	411515104067	PRIYA S
39.	411515104069	PRIYANKA P
40.	411515104070	PUNEETH SAHADEV H
41.	411515104071	RAMYA R
42.	411515104072	RANJITH KUMAR D
43.	411515104073	RANJITH KUMAR R
44.	411515104075	RONALD LANTON
45.	411515104076	ROSELINE Y
46.	411515104082	SANTHOSH P
47.	411515104083	SANTHOSH KUMAR J
48.	411515104086	SARATH KUMAR S
49.	411515104090	SHAMKUMAR R
50.	411515104091	SHARATH KUMAR L R
51.	411515104092	SHRIHARI P
52.	411515104093	SINDHUJA N
53.	411515104095	SNEHA D
54.	411515104097	SRI LAKSHMIJA R
55.	411515104099	SRI SAI GANGULY T P
56.	411515104100	SUBALAKSHMI M
57.	411515104102	SURESH JUSTIN S
58.	411515104104	SWAPNA K
59.	411515104108	THULASI DASS N

60.	411515104110	UDAYA KIRAN B
61.	411515104112	VENKATESH PRASAD S
62.	411515104113	VIDDYA R
63.	411515104114	VIDHYASRI A
64.	411515104115	VIJAYAKUMAR M
65.	411515104117	VINODHINI M
66.	411515104118	YESHWANTH S
67.	411515104004	AKASH K
68.	411515104005	AKASH R
69.	411515104006	AKHIL BABU E H
70.	411515104008	ANUMITHA M
71.	411515104009	ARAVIND KRISHNAN V S R
72.	411515104013	BUVANESH C I
73.	411515104017	DHARSHAN D
74.	411515104019	DINESH K
75.	411515104020	DINESH P
76.	411515104021	DINESH KUMAR M
77.	411515104023	GEETHA R
78.	411515104025	HANUMESHPRIYA M
79.	411515104030	KARTHI V V
80.	411515104033	KAVIN C
81.	411515104039	KUMARAVEL V

82.	411515104040	LINGESH S
83.	411515104044	LOKESH N K
84.	411515104048	MARIA ROGER KALVIN
85.	411515104056	NIVETHA R S
86.	411515104062	PRAVEEN M
87.	411515104063	PRAVEENRAJ M
88.	411515104064	PRAVIN RAJ C
89.	411515104068	PRIYANGA S
90.	411515104077	ROSHINE E
91.	411515104078	SABAREESH S V
92.	411515104079	SANGEETHA I
93.	411515104080	SANGEETHA S R
94.	411515104081	SANTHOSH M
95.	411515104084	SARAN RAJ S
96.	411515104085	SARANYA.L
97.	411515104088	SAVITHA R
98.	411515104089	SHAJI S
99.	411515104094	SIVAKUMAR S
100.	411515104101	SUJATHA S
101.	411515104103	SURIYAA T
102.	411515104105	TAMILARASAN S
103.	411515104106	THANGA RAMANUJAN K
104.	411515104107	THANIGAIVASAN K

105.	411515104116	VIJAYALAKSHMI M
106.	411515104119	YOGESHWARAN S
107.	411515104301	K.PREETHI
108.	411515104004	AKASH K
109.	411515104005	AKASH R
110.	411515104006	AKHIL BABU E H
111.	411515104008	ANUMITHA M
112.	411515104009	ARAVIND KRISHNAN V S R
113.	411515104013	BUVANESH C I
114.	411515104017	DHARSHAN D
115.	411515104019	DINESH K
116.	411515104020	DINESH P
117.	411515104021	DINESH KUMAR M
118.	411515104023	GEETHA R
119.	411515104025	HANUMESHPRIYA M
120.	411515104030	KARTHI V V

S. Anitha
Co-ordinator

A. Jeyaraj
HOD
10/1/20

Mannivakkam, Chennai 600048

DEPARTMENT OF COMPUTER SCIENCE AND ENGINEERING

ACADEMIC YEAR 2018-2019

Attendance Report for JAVA programming(16-07-2018 TO 20-07-2018&23-07-2018 TO 27-07-2018)

S..No.	Register Number	Name of the Student	16-07-18	17-07-18	18-07-18	19-07-18	20-07-18	16-07-18	17-07-18	18-07-18	19-07-18	20-07-18
1.	411515104001	ABILA	Abila	Abila	Abila	Abila	Abila	Abila	Abila	Abila	Abila	Abila
2.	411515104002	ADARSH R	Adarsh	Adarsh	Adarsh	Adarsh	Adarsh	Adarsh	Adarsh	Adarsh	Adarsh	Adarsh
3.	411515104003	AJAY SURVE C	Ajay	Ajay	Ajay	Ajay	Ajay	Ajay	Ajay	Ajay	Ajay	Ajay
4.	411515104007	ANGELINE T	Angeline	Angeline	Angeline	Angeline	Angeline	Angeline	Angeline	Angeline	Angeline	Angeline
5.	411515104010	ARUNA A	Aruna	Aruna	Aruna	Aruna	Aruna	Aruna	Aruna	Aruna	Aruna	Aruna
6.	411515104012	BALAYOGASHREE G	Bala	Bala	Bala	Bala	Bala	Bala	Bala	Bala	Bala	Bala
7.	411515104014	DEEPAK K	Deepak	Deepak	Deepak	Deepak	Deepak	Deepak	Deepak	Deepak	Deepak	Deepak
8.	411515104015	DEVARAJAN E	Devarajan	Devarajan	Devarajan	Devarajan	Devarajan	Devarajan	Devarajan	Devarajan	Devarajan	Devarajan
9.	411515104016	DHARMESH M	Dharmesh	Dharmesh	Dharmesh	Dharmesh	Dharmesh	Dharmesh	Dharmesh	Dharmesh	Dharmesh	Dharmesh
10.	411515104018	DHEEPIKA R	Dheepika	Dheepika	Dheepika	Dheepika	Dheepika	Dheepika	Dheepika	Dheepika	Dheepika	Dheepika
11.	411515104022	GALI MADHAN KUMAR	GMD	GMD	GMD	GMD	GMD	GMD	GMD	GMD	GMD	GMD
12.	411515104024	GEETHANJALI V	Geetha	Geetha	Geetha	Geetha	Geetha	Geetha	Geetha	Geetha	Geetha	Geetha
13.	411515104026	HARISH V	Harish	Harish	Harish	Harish	Harish	Harish	Harish	Harish	Harish	Harish
14.	411515104027	JASMINE A	Jasmine	Jasmine	Jasmine	Jasmine	Jasmine	Jasmine	Jasmine	Jasmine	Jasmine	Jasmine
15.	411515104028	JOHN BETSON J	John	John	John	John	John	John	John	John	John	John

16.	411515104029	JOSEPH NAVEEN KUMAR S	JNK	JNK	JNK	JNK	JNK	JNK	JNK	JNK	JNK	JNK	JNK
17.	411515104031	KARTHIKEYAN B	KBK	KBK	KBK	KBK	KBK	KBK	KBK	KBK	KBK	KBK	KBK
18.	411515104032	KARTHIK RAJA V	KRV	KRV	KRV	KRV	KRV	KRV	KRV	KRV	KRV	KRV	KRV
19.	411515104035	KEERTHIKA S	KS	KS	KS	KS	KS	KS	KS	KS	KS	KS	KS
20.	411515104036	KEIRON PRANAB T	KPT	KPT	KPT	KPT	KPT	KPT	KPT	KPT	KPT	KPT	KPT
21.	411515104037	KOWSALYA R	KR	KR	KR	KR	KR	KR	KR	KR	KR	KR	KR
22.	411515104038	KOWSALYA V	KV	KV	KV	KV	KV	KV	KV	KV	KV	KV	KV
23.	411515104041	LIPIYAN K	LK	LK	LK	LK	LK	LK	LK	LK	LK	LK	LK
24.	411515104045	MADHUMITHA V	MV	MV	MV	MV	MV	MV	MV	MV	MV	MV	MV
25.	411515104046	MAHESWARI M	MM	MM	MM	MM	MM	MM	MM	MM	MM	MM	MM
26.	411515104047	MANIKANDAN V	MV	MV	MV	MV	MV	MV	MV	MV	MV	MV	MV
27.	411515104049	MOHAMED ANSARI R	MR	MR	MR	MR	MR	MR	MR	MR	MR	MR	MR
28.	411515104050	MOHAN K	MK	MK	MK	MK	MK	MK	MK	MK	MK	MK	MK
29.	411515104052	MONIKA P M	MPM	MPM	MPM	MPM	MPM	MPM	MPM	MPM	MPM	MPM	MPM
30.	411515104054	SHASHANKA KOUSTUBH	SK	SK	SK	SK	SK	SK	SK	SK	SK	SK	SK
31.	411515104057	PAVITHRA B	PB	PB	PB	PB	PB	PB	PB	PB	PB	PB	PB
32.	411515104058	PAVITHRA R	PR	PR	PR	PR	PR	PR	PR	PR	PR	PR	PR
33.	411515104059	PRADHAKSHNA B	PB	PB	PB	PB	PB	PB	PB	PB	PB	PB	PB
34.	411515104060	PRAKASH C	PC	PC	PC	PC	PC	PC	PC	PC	PC	PC	PC
35.	411515104061	PRASANTH P	PP	PP	PP	PP	PP	PP	PP	PP	PP	PP	PP
36.	411515104065	PREETHI T	PT	PT	PT	PT	PT	PT	PT	PT	PT	PT	PT
37.	411515104066	PREM VIGNESH R	PRV	PRV	PRV	PRV	PRV	PRV	PRV	PRV	PRV	PRV	PRV

38.	411515104067	PRIYA S	Priya Priya Priya Priya Priya Priya Priya Priya Priya Priya Priya Priya
39.	411515104069	PRIYANKA P	Priyanka Priyanka Priyanka Priyanka Priyanka Priyanka Priyanka Priyanka Priyanka Priyanka Priyanka Priyanka
40.	411515104070	PUNEETH SAHADEV H	Puneeth Puneeth Puneeth Puneeth Puneeth Puneeth Puneeth Puneeth Puneeth Puneeth Puneeth Puneeth
41.	411515104071	RAMYA R	Ramya Ramya Ramya Ramya Ramya Ramya Ramya Ramya Ramya Ramya Ramya Ramya
42.	411515104072	RANJITH KUMAR D	Ranjith Ranjith Ranjith Ranjith Ranjith Ranjith Ranjith Ranjith Ranjith Ranjith Ranjith Ranjith
43.	411515104073	RANJITH KUMAR R	Ranjith Ranjith Ranjith Ranjith Ranjith Ranjith Ranjith Ranjith Ranjith Ranjith Ranjith Ranjith
44.	411515104075	RONALD LANTON	Ronald Ronald Ronald Ronald Ronald Ronald Ronald Ronald Ronald Ronald Ronald Ronald
45.	411515104076	ROSELINE Y	Roseline Roseline Roseline Roseline Roseline Roseline Roseline Roseline Roseline Roseline Roseline Roseline
46.	411515104082	SANTHOSH P	Santhosh Santhosh Santhosh Santhosh Santhosh Santhosh Santhosh Santhosh Santhosh Santhosh Santhosh Santhosh
47.	411515104083	SANTHOSH KUMAR J	Santhosh Santhosh Santhosh Santhosh Santhosh Santhosh Santhosh Santhosh Santhosh Santhosh Santhosh Santhosh
48.	411515104086	SARATH KUMAR S	Sarath Sarath Sarath Sarath Sarath Sarath Sarath Sarath Sarath Sarath Sarath Sarath
49.	411515104090	SHAMKUMAR R	Sham Sham Sham Sham Sham Sham Sham Sham Sham Sham Sham Sham Sham
50.	411515104091	SHARATH KUMAR L R	Sharath Sharath Sharath Sharath Sharath Sharath Sharath Sharath Sharath Sharath Sharath Sharath
51.	411515104092	SHRIHARI P	Shrihari Shrihari Shrihari Shrihari Shrihari Shrihari Shrihari Shrihari Shrihari Shrihari Shrihari Shrihari
52.	411515104093	SINDHUJA N	Sindhuja Sindhuja Sindhuja Sindhuja Sindhuja Sindhuja Sindhuja Sindhuja Sindhuja Sindhuja Sindhuja Sindhuja
53.	411515104095	SNEHA D	Sneha Sneha Sneha Sneha Sneha Sneha Sneha Sneha Sneha Sneha Sneha Sneha Sneha
54.	411515104097	SRI LAKSHMIJA R	Lakshmi Lakshmi Lakshmi Lakshmi Lakshmi Lakshmi Lakshmi Lakshmi Lakshmi Lakshmi Lakshmi Lakshmi
55.	411515104099	SRI SAI GANGULY T P	Sai Sai Sai Sai Sai Sai Sai Sai Sai Sai Sai Sai Sai
56.	411515104100	SUBALAKSHMI M	Subalakshmi Subalakshmi Subalakshmi Subalakshmi Subalakshmi Subalakshmi Subalakshmi Subalakshmi Subalakshmi Subalakshmi Subalakshmi
57.	411515104102	SURESH JUSTIN S	Suresh Suresh Suresh Suresh Suresh Suresh Suresh Suresh Suresh Suresh Suresh Suresh
58.	411515104104	SWAPNA K	Swapna Swapna Swapna Swapna Swapna Swapna Swapna Swapna Swapna Swapna Swapna Swapna
59.	411515104108	THULASI DASS N	Thulasi Thulasi Thulasi Thulasi Thulasi Thulasi Thulasi Thulasi Thulasi Thulasi Thulasi Thulasi

60.	411515104110	UDAYA KIRAN B	Uda Uda Uda Uda Uda Uda Uda Uda Uda Uda
61.	411515104112	VENKATESH PRASAD S	Ven Ven Ven Ven Ven Ven Ven Ven Ven Ven
62.	411515104113	VIDDYA R	Vidy Vidy Vidy Vidy Vidy Vidy Vidy Vidy Vidy Vidy
63.	411515104114	VIDHYASRI A	Vids Vids Vids Vids Vids Vids Vids Vids Vids Vids
64.	411515104115	VIJAYAKUMAR M	Vija Vija Vija Vija Vija Vija Vija Vija Vija Vija
65.	411515104117	VINODHINI M	Vino Vino Vino Vino Vino Vino Vino Vino Vino Vino
66.	411515104118	YESHWANTH S	Yes Yes Yes Yes Yes Yes Yes Yes Yes Yes
67.	411515104004	AKASH K	AB AB AB AB AB AB AB AB AB AB
68.	411515104005	AKASH R	Aka Aka Aka Aka Aka Aka Aka Aka Aka Aka
69.	411515104006	AKHIL BABU E H	Aka Aka Aka Aka Aka Aka Aka Aka Aka Aka
70.	411515104008	ANUMITHA M	Anu Anu Anu Anu Anu Anu Anu Anu Anu Anu
71.	411515104009	ARAVIND KRISHNAN V S R	Ara Ara Ara Ara Ara Ara Ara Ara Ara Ara
72.	411515104013	BUVANESH C I	AB AB AB AB AB AB AB AB AB AB
73.	411515104017	DHARSHAN D	Dha Dha Dha Dha Dha Dha Dha Dha Dha Dha
74.	411515104019	DINESH K	Din Din Din Din Din Din Din Din Din Din
75.	411515104020	DINESH P	Din Din Din Din Din Din Din Din Din Din
76.	411515104021	DINESH KUMAR M	AB AB AB AB AB AB AB AB AB AB
77.	411515104023	GEETHA R	Gee Gee Gee Gee Gee Gee Gee Gee Gee Gee
78.	411515104025	HANUMESH PRIYA M	AB AB AB AB AB AB AB AB AB AB
79.	411515104030	KARTHI V V	Kar Kar Kar Kar Kar Kar Kar Kar Kar Kar
80.	411515104033	KAVIN C	Kav Kav Kav Kav Kav Kav Kav Kav Kav Kav
81.	411515104039	KUMARAVEL V	Kuma Kuma Kuma Kuma Kuma Kuma Kuma Kuma Kuma Kuma

82.	411515104040	LINGESH S	Lings	Lings	Lings	Lings	Lings	Lings	Lings	Lings	Lings	Lings	Lings	Lings
83.	411515104044	LOKESH N K	NKL	NKL	NKL	NKL	NKL	NKL	NKL	NKL	NKL	NKL	NKL	NKL
84.	411515104048	MARIA ROGER KALVIN	MAR	MAR	MAR	MAR	MAR	MAR	MAR	MAR	MAR	MAR	MAR	MAR
85.	411515104056	NIVETHA R S	NVS	NVS	NVS	NVS	NVS	NVS	NVS	NVS	NVS	NVS	NVS	NVS
86.	411515104062	PRAVEEN M	Pravm	Pravm	Pravm	Pravm	Pravm	Pravm	Pravm	Pravm	Pravm	Pravm	Pravm	Pravm
87.	411515104063	PRAVEENRAJ M	MPR	MPR	MPR	MPR	MPR	MPR	MPR	MPR	MPR	MPR	MPR	MPR
88.	411515104064	PRAVIN RAJ C	PRC	PRC	PRC	PRC	PRC	PRC	PRC	PRC	PRC	PRC	PRC	PRC
89.	411515104068	PRIYANGA S	PS	PS	PS	PS	PS	PS	PS	PS	PS	PS	PS	PS
90.	411515104077	ROSHINE E	RE	RE	RE	RE	RE	RE	RE	RE	RE	RE	RE	RE
91.	411515104078	SABAREESH S V	SSV	SSV	SSV	SSV	SSV	SSV	SSV	SSV	SSV	SSV	SSV	SSV
92.	411515104079	SANGEETHA I	SI	SI	SI	SI	SI	SI	SI	SI	SI	SI	SI	SI
93.	411515104080	SANGEETHA S R	SSR	SSR	SSR	SSR	SSR	SSR	SSR	SSR	SSR	SSR	SSR	SSR
94.	411515104081	SANTHOSH M	SM	SM	SM	SM	SM	SM	SM	SM	SM	SM	SM	SM
95.	411515104084	SARAN RAJ S	SRS	SRS	SRS	SRS	SRS	SRS	SRS	SRS	SRS	SRS	SRS	SRS
96.	411515104085	SARANYA L	SL	SL	SL	SL	SL	SL	SL	SL	SL	SL	SL	SL
97.	411515104088	SAVITHA R	SR	SR	SR	SR	SR	SR	SR	SR	SR	SR	SR	SR
98.	411515104089	SHAJI S	SS	SS	SS	SS	SS	SS	SS	SS	SS	SS	SS	SS
99.	411515104094	SIVAKUMAR S	Siva	Siva	Siva	Siva	Siva	Siva	Siva	Siva	Siva	Siva	Siva	Siva
100.	411515104101	SUJATHA S	SS	SS	SS	SS	SS	SS	SS	SS	SS	SS	SS	SS
101.	411515104103	SURIYAA T	ST	ST	ST	ST	ST	ST	ST	ST	ST	ST	ST	ST
102.	411515104105	TAMILARASAN S	TAS	TAS	TAS	TAS	TAS	TAS	TAS	TAS	TAS	TAS	TAS	TAS
103.	411515104106	THANGA RAMANUJAN K	TK	TK	TK	TK	TK	TK	TK	TK	TK	TK	TK	TK
104.	411515104107	THANIGAIVASAN K	TK	TK	TK	TK	TK	TK	TK	TK	TK	TK	TK	TK

105.	411515104116	VIJAYALAKSHMI M	Vl	Vl	Vl	Vl	Vl	Vl	Vl	Vl	Vl	Vl	Vl
106.	411515104119	YOGESHWARAN S	Yog	Yoga	Yoga	Yoga	Yoga	Yoga	Yoga	Yoga	Yoga	Yoga	Yoga
107.	411515104301	K.PREETHI	Pre	Preethi	Preethi	Preethi	Preethi	Preethi	Preethi	Preethi	Preethi	Preethi	Preethi
108.	411515104004	AKASH K	Aka	Aka	Aka	Aka	Aka	Aka	Aka	Aka	Aka	Aka	Aka
109.	411515104005	AKASH R	Aka	Aka	Aka	Aka	Aka	Aka	Aka	Aka	Aka	Aka	Aka
110.	411515104006	AKHIL BABU E H	Aki	Aki	Aki	Aki	Aki	Aki	Aki	Aki	Aki	Aki	Aki
111.	411515104008	ANUMITHA M	Anu	Anu	Anu	Anu	Anu	Anu	Anu	Anu	Anu	Anu	Anu
112.	411515104009	ARAVIND KRISHNAN V S R	Arav	Arav	Arav	Arav	Arav	Arav	Arav	Arav	Arav	Arav	Arav
113.	411515104013	BUVANESH C I	Buv	Buv	Buv	Buv	Buv	Buv	Buv	Buv	Buv	Buv	Buv
114.	411515104017	DHARSHAN D	Dhar	Dhar	Dhar	Dhar	Dhar	Dhar	Dhar	Dhar	Dhar	Dhar	Dhar
115.	411515104019	DINESH K	Din	Din	Din	Din	Din	Din	Din	Din	Din	Din	Din
116.	411515104020	DINESH P	Din	Din	Din	Din	Din	Din	Din	Din	Din	Din	Din
117.	411515104021	DINESH KUMAR M	Din	Din	Din	Din	Din	Din	Din	Din	Din	Din	Din
118.	411515104023	GEETHA R	Gee	Gee	Gee	Gee	Gee	Gee	Gee	Gee	Gee	Gee	Gee
119.	411515104025	HANUMESHPRIYA M	AB	AB	AB	AB	AB	AB	AB	AB	AB	AB	AB
120.	411515104030	KARTHI V V	Kart	Kart	Kart	Kart	Kart	Kart	Kart	Kart	Kart	Kart	Kart

S. Smith
Co-ordinator

[Signature]
HOD

[Signature]

Dr. R. PALSON KENNEDY, M.E., Ph.D.
PRINCIPAL
PERI INSTITUTE OF TECHNOLOGY
Maanivakkam, Chennai - 600 048

PERI INSTITUTE OF TECHNOLOGY

Mannivakkam, Chennai 600048

DEPARTMENT OF COMPUTER SCIENCE AND ENGINEERING

ACADEMIC YEAR 2018-2019

FEEDBACK FORM

DATE:

27/01/2018

Name of the Student: Ajith.M
Register No: 411518104006
Year/Semester 3rd year
Course Code: CS018
Course Name: Java programming

1. What is your assessment of the course material?

The course material very good.

2. How effective was the instructor's delivery of the content?

The delivery content very clear and explain

3. Rate the overall quality of the program.

(Four star)

4. Would you suggest this program to your peers or underclassmen?

Yes

5. Suggestions for enhancement, if any:

No suggestion

Signature of the Student

Ajith

PERI INSTITUTE OF TECHNOLOGY

Mannivakkam, Chennai 600048

DEPARTMENT OF COMPUTER SCIENCE AND ENGINEERING

ACADEMIC YEAR 2018-2019

FEEDBACK FORM

ACADEMIC YEAR 2018-2019

DATE: 27.07.2018

Name of the Student: AVINASH.M
Register No: 411518101015
Year/Semester: iii
Course Code: CS018
Course Name: JAVA PROGRAMING

1. What is your assessment of the course material?

The assessment of the course material. It is very useful for exam

2. How effective was the instructor's delivery of the content?

The instructor delivery of the content is very useful

3. Rate the overall quality of the program.

Out of 5 star

4. Would you suggest this program to your peers or underclassmen?

Yes, I suggest this program to my underclassmen

5. Suggestions for enhancement, if any:

No.

Signature of the Student

Avinash.



Shan Software services



This is to Certify that

P.DINESH

has successfully completed the course of
CORE JAVA *on July-2018.*

A handwritten signature in blue ink is located in the bottom right corner. The signature is stylized and appears to read "V.G. Shanmugam".

Mr. V.G. Shanmugam
Founder & CEO



Shan Software services



This is to Certify that

A.ARUNA

has successfully completed the course of

CORE JAVA *on July-2018.*

A handwritten signature in blue ink is located in the bottom right area of the certificate. The signature is stylized and appears to read "V.G. Shanmugam".

Mr. V.G. Shanmugam
Founder & CEO



Shan Software services



This is to Certify that

GEETHA.R

has successfully completed the course of
CORE JAVA *on July-2018.*

A handwritten signature in blue ink, appearing to read "V.G. Shanmugam".

Mr. V.G. Shanmugam
Founder & CEO

PERI

INSTITUTE OF TECHNOLOGY

Mannivakkam, Chennai 600048

DEPARTMENT OF COMPUTER SCIENCE AND ENGINEERING

ACADEMIC YEAR 2018-2019

Ref: PERIIT /CSE/CC/2018-2019/03

DATE: 05-07-2018

CIRCULAR

This is to inform that the following enrolled students will have PYTHON PROGRAMMING training on the following scheduled date and all of you attend regularly and get benefits of this training. This training will be held on the following venue.

DATE : 11-09-2018 TO 15-09-2018

TIME : 8.30 AM – 3.30 PM

PLACE: CONFERENCE HALL

Coordinator

Head of the Department

Copy To:

1. Principal
2. Vice – Principal
3. IQAC
4. Faculty Members – CSE Staffs
5. Main – Notice Board

PERI INSTITUTE OF TECHNOLOGY

Mannivakkam, Chennai 600048

DEPARTMENT OF COMPUTER SCIENCE AND ENGINEERING

ACADEMIC YEAR 2018-2019

Minutes of the Meeting

Course name: Work Shop on Python Programming

Venue: CSE Staff Room, Beta Block ,PERI IT

Date:09/07/2018 **Time:**10:00 AM-10:15AM

Agenda of the meeting:

1. Syllabus preparation
2. Tentative Time Table
3. Assessment method

Members present:

1. Dr.K.Varalakshmi,HOD/CSE
2. Mr Mohan Palaniswamy PROJECT TEAM LEADER , PERI SOFTWARE SOLUTIONS
3. Mrs S Vinitha, AP/CSE
4. Mrs N SharmilaDeviAP/CSE

The meeting commenced with Mrs S.Vinitha the Coordinator, welcoming all the committee members and outlining the agenda for discussion.

Agenda Item 1:Syllabus preparation

She briefed the committee about the need for the "Python Programming" workshop. And emphasized that the syllabus should align with the course objectives

Agenda Item 2: Tentative Time Table

Mrs S Vinitha informed the members that the timetable should adhere to the requirements set forth by the university. The subject expert has been notified about the tentative timetable to ensure its feasibility.

Agenda Item 3: Assessment method

Assessments would be conducted at the end of the course to evaluate the participants

Coordinator

Senior faculty member

HOD/CSE

PRINCIPAL

Dr. R. PALSON KENNEDY, M.E., Ph.D.
PRINCIPAL
PERI INSTITUTE OF TECHNOLOGY
Mannivakkam, Chennai - 600 048

PERI INSTITUTE OF TECHNOLOGY

Mannivakkam, Chennai 600048

DEPARTMENT OF COMPUTER SCIENCE AND ENGINEERING

ACADEMIC YEAR 2018-2019

Course Code: CS019

Course Name: Python Programming

This course is designed to equip you with the essential skills and knowledge needed to kick start your career in software development using the Python Programming. It includes of diverse applications of Python Programming in software development, discovering how it streamlines the development process and enhances the performance and scalability of applications.

COURSE OBJECTIVES

- To Understand the fundamental concepts of algorithms and their role in problem-solving.
- To Familiarize with the Python interpreter and its interactive mode.
- To Learn to use conditional statements in Python: if, if-else, and if-elif-else structures.
- To learn the Introduce function composition and recursion.
- To Provide knowledge about using and creating modules and packages.

EVENT SCHEDULE

COMPANY	EVENT	DATE & TIME
MR.MOHAN PALANISAMY PROJECT TEAM LEADER PERI SOFTWARE SOLUTIONS	PYTHON PROGRAMMING Workshop	11-09-2018 TO 14-09-2018 8.30 AM TO 3.30 PM VENUE : PERIIT CONFERENCE HALL
Participation	Ist year Students	

HOD/CSE

PERI INSTITUTE OF TECHNOLOGY

Mannivakkam-48

Department of Computer Science and Engineering

TIME TABLE

Course Code: CS019

Year: 1st year students

Course Name: Python Programming -Workshop

Session: FN &AN

Particulars	Session	Topic covered
<p align="center">DATE : 11-09-2018 TO 14-09-2018</p> <p align="center">TIME : 8.30 AM – 3.30 PM</p> <p align="center">VENUE: CONFERENCE HALL</p>	FN &AN	<p>UNIT I ALGORITHMIC PROBLEM SOLVING Algorithms, building blocks of algorithms (statements, state, control flow, functions), notation (pseudo code, flow chart, programming language), algorithmic problem solving, simple strategies for developing algorithms (iteration, recursion).</p>
	FN &AN	<p>UNIT II DATA, EXPRESSIONS, STATEMENTS Python interpreter and interactive mode; values and types: int, float, boolean, string, and list; variables, expressions, statements, tuple assignment, precedence of operators, comments; modules and functions, function definition and use, flow of execution, parameters and arguments.</p>
	FN &AN	<p>UNIT III CONTROL FLOW, FUNCTIONS Conditionals: Boolean values and operators, conditional (if), alternative (if-else), chained conditional (if-elif-else); Iteration: state, while, for, break, continue, pass; Fruitful functions: return values, parameters, local and global scope, function composition, recursion; Strings: string slices, immutability, string functions and methods, string module; Lists as arrays.</p>
	FN &AN	<p>UNIT IV LISTS, TUPLES, DICTIONARIES Lists: list operations, list slices, list methods, list loop, mutability, aliasing, cloning lists, list parameters; Tuples: tuple assignment, tuple as return value; Dictionaries: operations and methods; advanced list processing – list comprehension.</p>
	FN &AN	<p>UNIT V FILES, MODULES, PACKAGES Files and exception: text files, reading and writing files, format operator; command line arguments, errors and exceptions, handling exceptions, modules, packages; Illustrative programs: word count.</p>

PERI INSTITUTE OF TECHNOLOGY

Mannivakkam, Chennai 600048

DEPARTMENT OF COMPUTER SCIENCE AND ENGINEERING

ACADEMIC YEAR 2018-2019

SYLLABUS

MODULE 1: ALGORITHMIC PROBLEM SOLVING

Algorithms, building blocks of algorithms (statements, state, control flow, functions), notation (pseudo code, flow chart, programming language), algorithmic problem solving, simple strategies for developing algorithms (iteration, recursion). Illustrative problems: find minimum in a list, insert a card in a list of sorted cards, guess an integer number in a range, Towers of Hanoi.

MODULE II: DATA, EXPRESSIONS, STATEMENTS

Python interpreter and interactive mode; values and types: int, float, boolean, string, and list; variables, expressions, statements, tuple assignment, precedence of operators, comments; modules and functions, function definition and use, flow of execution, parameters and arguments; Illustrative programs: exchange the values of two variables, circulate the values of n variables, distance between two points.

MODULE III: CONTROL FLOW, FUNCTIONS

Conditionals: Boolean values and operators, conditional (if), alternative (if-else), chained conditional (if-elif-else); Iteration: state, while, for, break, continue, pass; Fruitful functions: return values, parameters, local and global scope, function composition, recursion; Strings: string slices, immutability, string functions and methods, string module; Lists as arrays. Illustrative programs: square root, gcd, exponentiation, sum an array of numbers, linear search, binary search.

MODULE IV: LISTS, TUPLES, DICTIONARIES

Lists: list operations, list slices, list methods, list loop, mutability, aliasing, cloning lists, list parameters; Tuples: tuple assignment, tuple as return value; Dictionaries: operations and methods; advanced list processing – list comprehension; Illustrative programs: selection sort, insertion sort, mergesort, histogram.

MODULE V :FILES, MODULES, PACKAGES

Files and exception: text files, reading and writing files, format operator; command line arguments, errors and exceptions, handling exceptions, modules, packages; Illustrative programs: word count, copy file

Coordinator

HOD/CSE



Mannivakkam, Chennai 600048

DEPARTMENT OF COMPUTER SCIENCE AND ENGINEERING

ACADEMIC YEAR 2018-2019

Students Name List for PYTHON PROGRAMMING (11.09.2018 to 14.09.2018)

S..No.	Register Number	Name of the Student
1.	411518104001	AAKASH.B
2.	411518104002	ABINAYA.S
3.	411518104003	ABISHAKE GJ
4.	411518104004	ADHARSH N
5.	411518104005	AISHWARYA B
6.	411518104006	AJITH
7.	411518104007	AKHIL KUMAR M B
8.	411518104008	AKILA S
9.	411518104009	AL SHAJI.I
10.	411518104010	ANAND.C
11.	411518104011	ANANTH.LN
12.	411518104012	ANIRUDDH.R.K.
13.	411518104013	ANITHA.S
14.	411518104014	ASHWIN BALAJI.S
15.	411518104015	AIVINASH.M
16.	411518104016	BALARISHI S

17.	411518104017	BHUVANESHWARI.V
18.	411518104018	CHARAN M
19.	411518104020	CHITTIPIREDDY AKASH.C
20.	411518104021	DALISH PRINCA WILLIAM
21.	411518104022	DELHI BABU. R
22.	411518104023	DESIREDDYGARI CHANIKYA
23.	411518104024	DHANUSH.B
24.	411518104026	GANESH G
25.	411518104027	GOKUL.S
26.	411518104028	GOKULA KRISHNAN.R
27.	411518104029	HEMAKUMAR.G
28.	411518104030	GUHAN.P
29.	411518104031	GURUNATH M
30.	411518104032	HEMALATHA.V
31.	411518104033	HEMAPRIYA THARSHAN.J
32.	411518104034	JAGRITI CHATTERJEE
33.	411518104035	JAYANTH.S
34.	411518104036	JAYARAM.G.S
35.	411518104037	JOTHI KRISHNAN.K
36.	4115181044039	KARTHIK.N
37.	411518104040	KASTHURI. A
38.	411518104041	KEERTHANA. S
39.	411518104042	KOTA VENKATA MADHAVA REDDY
40.	411518104043	LOGESH N

41.	411518104044	JASWANTH REDDY.M
42.	411518104045	MAFISHYA JASPER.J
43.	411518104046	MALATHI.A
44.	411518104048	MOHAMED KAMALUDEEN.M
45.	411518104049	MOHAMMED ALAMEEN.A
46.	411518104050	MOHAMMED IBRAHIM M
47.	411518104051	MOHANASELVI S
48.	411518104052	MOKINDER S
49.	411518104053	MONISHWER ROSHAN B N
50.	411518104107	THIRUVENGADAM.S
51.	411518104301	NARMADHA.S
52.	411518104019	CHATHURYA S
53.	411518104054	MUGESH P
54.	411518104055	NANTHINI K
55.	411518104056	NAVANEETHA KRISHNAN M
56.	411518104057	NAVEEN B
57.	411518104058	NIJANTHAN D
58.	411518104060	NITHISH KUMAR K
59.	411518104061	NITHYA PRAKASH A
60.	411518104062	NITHYA SHREE S
61.	411518104063	NIVETHA M
62.	411518104064	NIZAMUDDIN S
63.	411518104065	PALAVAKAM CHARAN
64.	411518104066	PARTHIPAN M

89.	411518104095	SHWETHA P T
90.	411518104096	SIBI A R
91.	411518104097	SONIA P V
92.	411518104098	SOPHIA DAVID
93.	411518104099	SOWMIYA J
94.	411518104100	SUBINRAJ C
95.	411518104101	SUGAN M D
96.	411518104102	SUGANYA R
97.	411518104103	SWETHA G
98.	411518104104	TARUN S
99.	411518104105	THABEETHAL AGNES A
100.	411518104106	THENMOZHI V
101.	411518104108	VALLURU DEEKSHITHA
102.	411518104109	VIGNESH R
103.	411518104110	VIGNESH S
104.	411518104111	VIKSHARA K
105.	411518104112	VINODHKUMAR R
106.	411518104114	YOGESH K
107.	411518104115	YOGESHWARI N
108.	411518104125	YUVASHRI U
109.	411518104302	NAVEEN C
110.	411518104701	CATHERINE RUTH W D

Shwetha
Co-ordinator

Dr. R. Palson Kennedy

Dr. R. PALSON KENNEDY, M.E., Ph.D.
PRINCIPAL
PERI INSTITUTE OF TECHNOLOGY
Mannivakkam, Chennai - 600 048

Dr. R. Palson Kennedy
HOD

Mannivakkam, Chennai 600048

DEPARTMENT OF COMPUTER SCIENCE AND ENGINEERING

ACADEMIC YEAR 2018-2019

Attendance Report for PYTHON PROGRAMMING (11.09.2018 to 14.09.2018)

S.No.	Register Number	Name of the Student	11.09.18	12.09.18	13.09.18	14.09.18
1.	411518104001	AAKASH.B	Aakash	Aakash	Aakash	Aakash
2.	411518104002	ABINAYA.S	Abinaya	Abinaya	Abinaya	Abinaya
3.	411518104003	ABISHAKE GJ	Abi	Abi	Abi	Abi
4.	411518104004	ADHARSH N	Adh	Adh	A	Adh
5.	411518104005	AISHWARYA B	Aish	Aish	Aish	Aish
6.	411518104006	AJITH	Ajit	Ajit	Ajit	Ajit
7.	411518104007	AKHIL KUMAR M B	Akhil	A	Akhil	Akhil
8.	411518104008	AKILA S	Akila	Akila	Akila	Akila
9.	411518104009	AL SHAJI	Alshij	Alshij	Alshij	Alshij
10.	411518104010	ANAND.C	Anand	Anand	Anand	Anand
11.	411518104011	ANANTH.N	Ananth	Ananth	Ananth	Ananth
12.	411518104012	ANIRUDDH.R.K.	Anir	Anir	Anir	Anir
13.	411518104013	ANITHA.S	Anitha	Anitha	Anitha	Anitha
14.	411518104014	ASHWIN BALAJI.S	Ashwin	Ashwin	Ashwin	Ashwin
15.	411518104015	AIVINASH.M	Aivin	Aivin	Aivin	Aivin
16.	411518104016	BALARISHI S	A	Bala	Bala	Bala

17.	411518104017	BHUVANESHWARI.V	Bhuvaniv	Bhuvaniv	Bhuv	Bhuv
18.	411518104018	CHARAN M	CharanM	CharanM	CharanM	CharanM
19.	411518104020	CHITTIPIREDDY AKASH.C	Chittipireddy Akash.C	Chittipireddy Akash.C	Chittipireddy Akash.C	Chittipireddy Akash.C
20.	411518104021	DALISH PRINCA WILLIAM	Dalish Princa William	Dalish Princa William	Dalish Princa William	Dalish Princa William
21.	411518104022	DELHI BABU. R	Delhi Babu. R	Delhi Babu. R	Delhi Babu. R	Delhi Babu. R
22.	411518104023	DESIREDDYGARI CHANIKYA	Desireddygari Chanikya	Desireddygari Chanikya	Desireddygari Chanikya	Desireddygari Chanikya
23.	411518104024	DHANUSH.B	Dhanush.B	Dhanush.B	Dhanush.B	Dhanush.B
24.	411518104026	GANESH G	Ganesh G	Ganesh G	Ganesh G	Ganesh G
25.	411518104027	GOKUL.S	Gokul.S	Gokul.S	Gokul.S	Gokul.S
26.	411518104028	GOKULA KRISHNAN.R	Gokula Krishnan.R	Gokula Krishnan.R	Gokula Krishnan.R	Gokula Krishnan.R
27.	411518104029	HEMAKUMAR.G	Hemakumar.G	Hemakumar.G	Hemakumar.G	Hemakumar.G
28.	411518104030	GUHAN.P	Guhan.P	Guhan.P	Guhan.P	Guhan.P
29.	411518104031	GURUNATH M	Gurunath M	Gurunath M	Gurunath M	Gurunath M
30.	411518104032	HEMALATHA.V	Hemalatha.V	Hemalatha.V	Hemalatha.V	Hemalatha.V
31.	411518104033	HEMAPRIYA THARSHAN.J	Hemapriya Tharshan.J	Hemapriya Tharshan.J	Hemapriya Tharshan.J	Hemapriya Tharshan.J
32.	411518104034	JAGRITI CHATTERJEE	Jagrithi Chatterjee	Jagrithi Chatterjee	Jagrithi Chatterjee	Jagrithi Chatterjee
33.	411518104035	JAYANTH.S	Jayanth.S	Jayanth.S	Jayanth.S	Jayanth.S
34.	411518104036	JAYARAM.G.S	Jayaram.G.S	Jayaram.G.S	Jayaram.G.S	Jayaram.G.S
35.	411518104037	JOTHI KRISHNAN.K	Jothi Krishnan.K	Jothi Krishnan.K	Jothi Krishnan.K	Jothi Krishnan.K
36.	4115181044039	KARTHIK.N	Karthik.N	Karthik.N	Karthik.N	Karthik.N
37.	411518104040	KASTHURI. A	Kasthuri. A	Kasthuri. A	Kasthuri. A	Kasthuri. A
38.	411518104041	KEERTHANA. S	Keerthana. S	Keerthana. S	Keerthana. S	Keerthana. S
39.	411518104042	KOTA VENKATA MADHAVA REDDY	Kota Venkata Madhava Reddy	Kota Venkata Madhava Reddy	Kota Venkata Madhava Reddy	Kota Venkata Madhava Reddy
40.	411518104043	LOGESH N	Logesh N	Logesh N	Logesh N	Logesh N

41.	411518104044	JASWANTH REDDY.M	<u>Jasur</u>	<u>Jasur</u>	<u>Jasur</u>	<u>Jasur</u>
42.	411518104045	MAFISHYA JASPER.J	<u>mafia</u>	<u>mafia</u>	<u>mafia</u>	<u>mafia</u>
43.	411518104046	MALATHIA	<u>malathi</u>	<u>malathi</u>	<u>malathi</u>	<u>malathi</u>
44.	411518104048	MOHAMED KAMALUDEEN.M	<u>mohamed</u>	<u>mohamed</u>	<u>mohamed</u>	<u>mohamed</u>
45.	411518104049	MOHAMMED ALAMEEN.A	<u>Ma</u>	<u>Ma</u>	<u>Ma</u>	<u>Ma</u>
46.	411518104050	MOHAMMED IBRAHIM M	<u>MIB</u>	<u>MIB</u>	<u>MIB</u>	<u>MIB</u>
47.	411518104051	MOHANASELVI S	<u>Mohana</u>	<u>Mohana</u>	<u>Mohana</u>	<u>Mohana</u>
48.	411518104052	MOKINDER S	<u>moki</u>	<u>moki</u>	<u>moki</u>	<u>moki</u>
49.	411518104053	MONISHWER ROSHAN B N	<u>monish</u>	<u>monish</u>	<u>monish</u>	<u>monish</u>
50.	411518104107	THIRUVENGADAM.S	<u>Thiru</u>	<u>Thiru</u>	<u>Thiru</u>	<u>Thiru</u>
51.	411518104301	NARMADHA.S	<u>Narara</u>	<u>Narara</u>	<u>Narara</u>	<u>Narara</u>
52.	411518104019	CHATHURYA S	<u>Chath</u>	<u>Chath</u>	<u>Chath</u>	<u>Chath</u>
53.	411518104054	MUGESH P	<u>mugesh</u>	<u>mugesh</u>	<u>mugesh</u>	<u>mugesh</u>
54.	411518104055	NANTHINI K	<u>nanth</u>	<u>nanth</u>	<u>nanth</u>	<u>nanth</u>
55.	411518104056	NAVANEETHA KRISHNAN M	<u>Nav</u>	<u>Nav</u>	<u>Nav</u>	<u>Nav</u>
56.	411518104057	NAVEEN B	<u>Nav</u>	<u>Nav</u>	<u>Nav</u>	<u>Nav</u>
57.	411518104058	NIJANTHAN D	<u>Nija</u>	<u>Nija</u>	<u>Nija</u>	<u>Nija</u>
58.	411518104060	NITHISH KUMAR K	<u>nithish</u>	<u>nithish</u>	<u>nithish</u>	<u>nithish</u>
59.	411518104061	NITHYA PRAKASH A	<u>Nithya</u>	<u>Nithya</u>	<u>Nithya</u>	<u>Nithya</u>
60.	411518104062	NITHYA SHREE S	<u>Nithya</u>	<u>Nithya</u>	<u>Nithya</u>	<u>Nithya</u>
61.	411518104063	NIVETHA M	<u>Nive</u>	<u>Nive</u>	<u>Nive</u>	<u>Nive</u>
62.	411518104064	NIZAMUDDIN S	<u>Niza</u>	<u>Niza</u>	<u>Niza</u>	<u>Niza</u>
63.	411518104065	PALAVAKAM CHARAN	<u>Palav</u>	<u>Palav</u>	<u>Palav</u>	<u>Palav</u>
64.	411518104066	PARTHIPAN M	<u>Parthi</u>	<u>Parthi</u>	<u>Parthi</u>	<u>Parthi</u>

89.	411518104095	SHWETHA P T				
90.	411518104096	SIBI A R	Shudhapa Sibi AR	Shwetha p Sibi AR	Shwetha p Sibi AR	Shwetha p Sibi AR
91.	411518104097	SONIA P V				
92.	411518104098	SOPHIA DAVID	Sonpv Sophie	Sonpv Sophie	Sonpv Sophie	Sonpv Sophie
93.	411518104099	SOWMIYA J				
94.	411518104100	SUBINRAJ C	Subin Subin	Subin Subin	Subin Subin	Subin Subin
95.	411518104101	SUGAN M D	MDSu	AB	MDSu	MDSu
96.	411518104102	SUGANYA R				
97.	411518104103	SWETHA G	Suganya Gsu	Suganya Gsu	Suganya Gsu	Suganya Gsu
98.	411518104104	TARUN S				
99.	411518104105	THABEETHAL AGNES A				
100.	411518104106	THENMOZHI V				
101.	411518104108	VALLURU DEEKSHITHA	V. Thenmp vallu Deek	V. Thenmp vallu Deek	V. Thenmp vallu Deek	V. Thenmp vallu Deek
102.	411518104109	VIGNESH R				
103.	411518104110	VIGNESH S	AB	Vignesh	Vignesh	Vignesh
104.	411518104111	VIKSHARA K	Vignesh Kvll	Vignesh Kvll	Vignesh Kvll	Vignesh Kvll
105.	411518104112	VINODHKUMAR R	Vinodk Vvll	Vinodk Vvll	Vinodk Vvll	Vinodk Vvll
106.	411518104114	YOGESH K				
107.	411518104115	YOGESHWARI N	AB			
108.	411518104125	YUVASHRI U				
109.	411518104302	NAVEEN C	Naveen Naveen	Naveen Naveen	Naveen Naveen	Naveen Naveen
110.	411518104701	CATHERINE RUTH W D	CAN	CAN	CAN	CAN

Shwetha
Co-ordinator

(Handwritten signature)

(Handwritten signature)
HOD

Dr. R. PALSON KENNEDY, M.E., Ph.D.
PRINCIPAL
PERI INSTITUTE OF TECHNOLOGY
Maanivakkam, Chennai - 600 048

PERI

INSTITUTE OF TECHNOLOGY



A COURSE ON PYTHON

CERTIFICATE OF PARTICIPATION

This is to certify that DALISH PRINCA WILLIAM W of
Computer Science and Engineering has attended the
workshop on A COURSE ON PYTHON held on 11-09-2018 to 14-09-2018

SARAVANAN PERIASAMY
CHAIRMAN

SASIKUMAR VEERARAJAN
COO

R.PALSON KENNEDY
PRINCIPAL

PERI

INSTITUTE OF TECHNOLOGY



A COURSE ON PYTHON

CERTIFICATE OF PARTICIPATION

This is to certify that SONIA P.V. of
Computer Science and Engineering has attended the
workshop on A COURSE ON PYTHON held on 11-09-2018 to 14-09-2018

SARAVANAN PERIASAMY
CHAIRMAN

SASIKUMAR VEERARAJAN
COO

R.PALSON KENNEDY
PRINCIPAL

PERI

INSTITUTE OF TECHNOLOGY



A COURSE ON PYTHON

CERTIFICATE OF PARTICIPATION

This is to certify that ANAND C of Computer Science and Engineering has attended the workshop on A COURSE ON PYTHON held on 11-09-2018 to 14-09-2018

SARAVANAN PERIASAMY
CHAIRMAN

SASIKUMAR VEERARAJAN
COO

R.PALSON KENNEDY
PRINCIPAL

PERI INSTITUTE OF TECHNOLOGY

Mannivakkam, Chennai 600048

DEPARTMENT OF COMPUTER SCIENCE AND ENGINEERING

ACADEMIC YEAR 2018-2019

FEEDBACK FORM

DATE: 14/09/2018

Name of the Student: Mukesh. P
Register No: 411518104054
Year/Semester: III V
Course Code: CS019
Course Name: Python Programming

1. What is your assessment of the course material?

Assessment of the course material is advanced.

2. How effective was the instructor's delivery of the content?

The instructor delivers the content very clearly.

3. Rate the overall quality of the program.

Good (4 Star)

4. Would you suggest this program to your peers or underclassmen?

Yes

5. Suggestions for enhancement, if any:

Signature of the Student

Mukesh P.

PERI INSTITUTE OF TECHNOLOGY

Mannivakkam, Chennai 600048

DEPARTMENT OF COMPUTER SCIENCE AND ENGINEERING

ACADEMIC YEAR 2018-2019

FEEDBACK FORM

DATE: 14.9.2018

Name of the Student: Sonia. Pv
Register No: 411578104097
Year/Semester: 111 IV
Course Code: CS091 Python P
Course Name: Python Programming

1. What is your assessment of the course material?

Assessment of the course material
is advanced.

2. How effective was the instructor's delivery of the content?

The instructor's delivery of the
content very clearly

3. Rate the overall quality of the program.

Good (5 stars)

4. Would you suggest this program to your peers or underclassmen?

Yes

5. Suggestions for enhancement, if any:

no suggestions.

Sonia. Pv
Signature of the Student

PERI INSTITUTE OF TECHNOLOGY

Mannivakkam, Chennai 600048

DEPARTMENT OF ELECTRONICS AND COMMUNICATION ENGINEERING

ACADEMIC YEAR 2018-2019

Ref: PERIIT /ECE/Add-On Course/2018-19/01

Date: 03.07.2018

CIRCULAR

The Electronics and Communication Engineering Department of PERI IT has planned to conduct Add-on course titled “Embedded building blocks using Arduino Hands On for Young” for the Academic Year 2018-2019 for II,III & IV year ECE students.

S.No.	Year	Scheduled Date	Session 1	Session 2
1	II,III,IV	07.07.2018 -13.07.2018	10.00AM to 11.45AM	12.30PM to 3.30PM

Co-ordinator
3/7/18

Copy To:

1. Principal
2. Vice – Principal
3. IQAC
4. Faculty Members -ECE
5. Notice Board

Head of the Department
Head of the Department
ELECTRONICS AND COMMUNICATION ENGINEERING
PERI INSTITUTE OF TECHNOLOGY
CHENNAI - 600 048.

PERI INSTITUTE OF TECHNOLOGY

Mannivakkam, Chennai 600048

DEPARTMENT OF ELECTRONICS AND COMMUNICATION ENGINEERING

ACADEMIC YEAR 2018-2019

Minutes of the Meeting for Add-On Course-ECA018

Embedded Building Blocks using Arduino Hands On for Young

Venue: HOD Room, Beta Block , PERI

Date:05/07/2018 Time:1200pm-1.00pm

Agenda of the meeting:

1. Syllabus preparation
2. Tentative Time Table
3. Assessment method

Members present:

1. Ms.Jasmine Jeni, HOD/ECE
2. Mr.Senthil kumaran, Corporate Trainer, Scube Techno Academy.
3. Ms.K.Lakshmi priya, Co-ordinator
4. Dr.G.Charulatha, Associate Professor, ECE

Ms.Lakshmi priya Coordinator welcomed and briefed the committee members about the agenda.

Agenda Item 1: Syllabus preparation for Embedded Building blocks using Arduino Hands on for Young.

The syllabus is framed accordingly in order to meet the objectives of the course, various Universities, IITs, NITs syllabus has been taken into consideration for syllabus preparation.

Agenda Item 2: Tentative Time Table

The timetable is prepared as per the university requirement and communicated to the subject expert.

Agenda Item 3: Assessment method

Assessment will be conducted at the end of the course



Coordinator

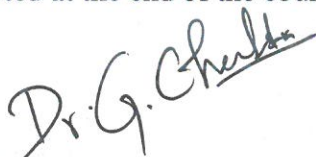

Senior faculty member



HOD/ECE



PRINCIPAL

Dr. R. PALSON KENNEDY, M.E., Ph.D.,
PRINCIPAL
PERI INSTITUTE OF TECHNOLOGY
Mannivakkam, Chennai - 600 048.

PERI INSTITUTE OF TECHNOLOGY

Mannivakkam, Chennai 600048

DEPARTMENT OF ELECTRONICS AND COMMUNICATION ENGINEERING

SHORT DESCRIPTION

Course Code: ECA 018

Course Name: Embedded Building blocks using Arduino Hands on for Young

An embedded system is a combination of hardware and software provided that both should be synchronized with each other. Some examples are as follows: industrial machines, automobiles, medical equipment, cameras, household appliances, airplanes, vending machines etc. The Arduino is an open-source computer hardware/software platform for building digital devices and interactive objects that can sense and control the physical world around them.

COURSE OBJECTIVES

- To understand and Knowledge of Processors of embedded Systems
- To learn how the Arduino platform works in terms of the physical board and libraries and the IDE (Integrated Development Environment)
- To enhance the knowledge about sensors and actuators
- To control Embedded system based devices using Arduino.

COURSE OUTCOMES:

- Make use of Arduino Library and Emulator and Knowledge of Arduino Software
- Learned about Analog, Digital, Power, Other Pins, External/USB power supply, reset button, and other components of Arduino Board
- Working on LCD monitor, Reading Various Sensor data on Serial Monitor and LCD Display.
- Design and implement Analog and Digital Sensors, Pull-Up/Down resistors and Examples of sensors , Connecting different sensors such as: Humidity, Heat/Temperature, proximity, IR, Motion, Accelerometer, Sound , Light, distance, Pressure, Thermal, Infrared, LDR etc. to Arduino Board

PERI INSTITUTE OF TECHNOLOGY

DEPARTMENT OF ELECTRONICS AND COMMUNICATION ENGINEERING

SYLLABUS

Embedded Building blocks using Arduino Hands on for Young

MODULE I: Embedded System design: Basics

What is Embedded System, Main Components of Embedded Systems, Constraints of Embedded System, Power dissipation. Embedded System Classifications(Small Scale, Medium Scale, Sophisticated) and its Components Processors:

General purpose, Single purpose, Application Specific, Concepts of microprocessor and microcontroller, and other Elements of Embedded System

MODULE II: Learning Arduino Platform

Microcontrollers, Programming Microcontrollers, Arduino Platform, The Boards, The Anatomy of an Arduino Board, The Development Environment.

Learning about Analog, Digital, Power, Other Pins, External/USB power supply, reset button, and other components of Arduino Board. Arduino Development Environment: Arduino Software, Different menus and Serial Monitor of Arduino IDE.

Acquiring the skills for writing Arduino Sketches, working with examples, Interfacing some led, switch, Potentiometer with Arduino

MODULE III: The Basics of Sensor & Actuators

Analog and Digital Sensors, Pull-Up/Down resistors and Examples of sensors , Connecting different sensors such as: Humidity, Heat/Temperature, proximity, IR Motion, Accelerometer, Sound , Light, distance, Pressure, Thermal, Infrared, LDR etc. to Arudino Board

MODULE IV: Controlling Embedded System Based Devices using Arduino

Working on LCD monitor, Reading Various Sensor data on Serial Monitor and LCD Display Actuators, Relay Switch, Servo Motor, Putting Things Together, Sensing the World, Reading from Analog Sensors



Coordinator



HOD/ECE

PERI INSTITUTE OF TECHNOLOGY
DEPARTMENT OF ELECTRONICS AND COMMUNICATION ENGINEERING

TIME TABLE

Course Code: EC A018

Year:II,III & IV

Course Name: Embedded Building blocks using Arduino Hands on for Young
Session: FN & AN

S.No	DATE	HOURS	TOPIC
1	07.07.18	3 rd -8th	What is Embedded System, Main Components of Embedded Systems, Constraints of Embedded System, Power dissipation.Embedded System Classifications(Small Scale,Medium Scale, Sophisticated) and its Components Processors:
2	09.07.18	3 rd -8th	General purpose, Single purpose,Application Specific, Concepts of microprocessor and microcontroller, and other Elements of Embedded System
3	10.07.18	3 rd -8th	Microcontrollers, Programming Microcontrollers, Arduino Platform, The Boards, The Anatomy of an Arduino Board, The Development Environment.
4	11.07.18	3 rd -8th	Learning about Analog, Digital, Power, Other Pins, External/USB power supply, reset button, and other components of Arduino Board.Arduino Development Environment: Arduino Software, Different menus and Serial Monitor of Arduino IDE.
5	12.07.18	3 rd -8th	Acquiring the skills for writing Arduino Sketches, working with examples, Interfacing some led, switch, Potentiometer with Arduino.Analog and Digital Sensors,
6	13.07.18	3 rd -8th	Connecting different sensors such as: Humidity, Heat/Temperature, etc. to Arudino Board.Working on LCD monitor, Reading Various Sensor data on Serial Monitor and LCD Display Actuators, Relay Switch, Servo Motor, Putting Things Together, Sensing the World.

Coordinator

HOD/ECE

**PERI INSTITUTE OF TECHNOLOGY
DEPARTMENT OF ECE
ACADEMIC YEAR 2018-2019
II/ECE**

S.NO.	REG. NO	STUDENT NAME
1	411517106001	AAKASH C.S
2	411517106002	AAKASH RAJ S
3	411517106003	ABDULLA A
4	411517106004	AGNISHA V.
5	411517106005	AILEEN MERCYBELL A
6	411517106006	AKASH S
7	411517106008	ANNAPUREDDY DHANA LAKSHMI A
8	411517106009	ARASAVALLI TEJA DURGA SAI S.
9	411517106010	ARUN K.S.
10	411517106011	ARUNESHWARAN M
11	411517106012	ASHIKA K
12	411517106013	BALAJI N
13	411517106014	VAMSI KRISHNA B.
14	411517106015	BHARATH BALAJI R
15	411517106016	BOYA VENKATA RAKESH B.
16	411517106018	CHINTALA.SUPRIYA S.
17	411517106019	CHUKKA MONICA B.
18	411517106020	DEEPIKA M.
19	411517106021	DELLI GANESH G
20	411517106022	DINESH V
21	411517106023	DIVYA PRIYA R.
22	411517106024	EURO SRI M.
23	411517106025	GADIKOTA DEEKSHITHA G.

**PERI INSTITUTE OF TECHNOLOGY
DEPARTMENT OF ECE
ACADEMIC YEAR 2018-2019
II/ECE**

24	411517106026	GADI MANO VARSHITH G.
25	411517106027	GANESH KARAN K
26	411517106028	GAYATHRI K
27	411517106029	GNANAPRASATH L
28	411517106030	GUPENDHIRAN S
29	411517106031	GURRALA HARI R.
30	411517106032	GURUDHARSAN B
31	411517106033	HARIHARAN K
32	411517106034	HARIPRIYA B.
33	411517106035	ILANGO M
34	411517106036	JAIGANESH S
35	411517106038	JAVANGULA MANICHAND J
36	411517106040	JOTHIKA A
37	411517106041	KALAIVANI K
38	411517106042	KAMALEESHWAR M
39	411517106043	KAMESH M
40	411517106044	KAMESH R
41	411517106045	KANICKAI RAJ J
42	411517106046	KARTHIC B
43	411517106047	KARTHIKEYAN A
44	411517106048	KATHIRAVAN G
45	411517106049	KAVIN J
46	411517106051	KEERTHANA L
47	411517106052	KEERTHI RAJAN A.S

**PERI INSTITUTE OF TECHNOLOGY
DEPARTMENT OF ECE
ACADEMIC YEAR 2018-2019
II/ECE**

48	411517106053	SASIDHAR NAIDU K
49	411517106054	KISHORE KUMAR M
50	411517106056	KRISHNARAJ V
51	411517106057	KUMARAN J
52	411517106058	LAKSHMI AISHWARYA R.
53	411517106059	LEENA S
54	411517106060	LOGESH S
55	411517106061	LOGESHWARI G.
56	411517106062	LOKESHKUMAR M.
57	411517106063	LOKESH KUMAR G
58	411517106064	LOKESHWARAN P
59	411517106065	MADHAN RAJ P.
60	411517106066	MANIBHARATHI S.
61	411517106067	MANISHA V.
62	411517106068	MARY K
63	411517106069	MOHAMMED SHAARIF K
64	411517106070	MOHANA N
65	411517106071	MONISHA M.
66	411517106072	KRANTHI KUMAR N
67	411517106076	KIRAN KUMAR REDDY O.
68	411517106077	PADMASHREE M.
69	411517106079	PRADEEP K. V
70	411517106081	PRAVEEN S
71	411517106082	RAGAVENDER S

PERI INSTITUTE OF TECHNOLOGY
DEPARTMENT OF ECE
ACADEMIC YEAR 2018-2019
II/ECE

72	411517106083	RAJA SHREE B
73	411517106084	RAKINI C.
74	411517106085	RAMAPRAKASH G.
75	411517106086	RAVEEN KUMAR M
76	411517106087	RUPA SRI V M
77	411517106088	SAI SRUTHI K
78	411517106089	SANDHIYA V
79	411517106090	SANJAY S
80	411517106091	SANTHANA KARTHICK D
81	411517106092	SELVA DHARSHINI V
82	411517106093	SELVA SOORIYA S
83	411517106094	SHANTHI V.
84	411517106095	SHARON GRACE BETSY G
85	411517106096	SHESHI KUMAR G.R
86	411517106097	SHIVAHARI P
87	411517106098	SIVA KUMAR S
88	411517106099	SIVA SARAVANAN K
89	411517106101	SRIRAM E.
90	411517106102	SUBALAKSHMI H
91	411517106104	UMA MAGHESWARI K
92	411517106105	YAMINI CHOWDARY U
93	411517106106	VALLARASU R
94	411517106107	VASANTH KUMAR.K
95	411517106108	VIGNESH A

**PERI INSTITUTE OF TECHNOLOGY
DEPARTMENT OF ECE
ACADEMIC YEAR 2018-2019
II/ECE**

96	411517106109	VIGNESH P
97	411517106110	VIJAYALAKSHMI G
98	411517106111	VIJITHRA V
99	411517106112	VINODHINI S
100	411517106113	VUNNAM SUCHARITHA V.
101	411517106114	YAKESH C
102	411517106115	YAZHIR ARAFATH A
103	411517106301	SUDALAI MUTHU
104	411517106302	SURYA
105	411517106303	VIGNESH . L

PERI INSTITUTE OF TECHNOLOGY
DEPARTMENT OF ECE
ACADEMIC YEAR 2018-2019
III/ECE

S.NO.	REG. NO	STUDENT NAME
1	411516106003	ANNIE MUTHABARANAM A
2	411516106005	ARSHAD AHMED M D
3	411516106006	ARUL KUMAR S
4	411516106010	ASRAF A.
5	411516106012	BHUVANAA C.
6	411516106013	DANIEL ANCING E
7	411516106015	DEVANAND M.
8	411516106022	IYYANARAPPAN M
9	411516106023	JACKLIN EMILDA S.
10	411516106026	JAYASHREE S.
11	411516106027	KEERTHANA C.K
12	411516106028	KESHAV KUMAR J.
13	411516106029	KIRTHIKA S.
14	411516106032	LOKESHWARAN B.
15	411516106033	MAHENDRA A
16	411516106034	MAHESH KUMAR G
17	411516106035	MALATHY T.
18	411516106037	MANJU BHARKAVI M
19	411516106038	MARIA THEENA L.T
20	411516106041	NIVAS A.T
21	411516106042	NIVETHA J.
22	411516106043	NIVETHA M

**PERI INSTITUTE OF TECHNOLOGY
DEPARTMENT OF ECE
ACADEMIC YEAR 2018-2019
III/ECE**

23	411516106044	PAVITHRA R
24	411516106048	PRETHI SAI L.
25	411516106049	RADHIKA G
26	411516106050	RAGINI J
27	411516106051	RAJESH S
28	411516106052	RAMYA S
29	411516106053	RANJITH SREEKAR A.G
30	411516106054	RIYAZ AHAMED A
31	411516106055	SANDHYA M
32	411516106056	SANTHOSH M
33	411516106057	SHIVALI ANGRAL
34	411516106058	SOWMYA S.
35	411516106062	UMA SHANKAR R
36	411516106064	VIGNESH N.
37	411516106301	BHAVANA T
38	411516106302	KANCHANA A
39	411516106303	KOYALAMUDI SAI KRISHNA
40	411516106307	YUVANSHANKAR P.D
41	411516106701	ACHANTA TRINADH KUMAR A
42	411516106001	AKASH B.
43	411516106008	ARUNACHALAM K
44	411516106009	ASIF ALI A
45	411516106011	BALAJI K

PERI INSTITUTE OF TECHNOLOGY
DEPARTMENT OF ECE
ACADEMIC YEAR 2018-2019
III/ECE

46	411516106014	DEEN KUMARAN V
47	411516106016	DILIP KUMAR T.
48	411516106018	GOWRI S.
49	411516106019	HARIHARAN C
50	411516106021	HENRY SOLOMON J
51	411516106024	JAGAN L.
52	411516106025	JAI PRAKASH V.
53	411516106030	KIRUBHAKARAN M.
54	411516106040	NAVEENKUMAR V
55	411516106045	POORNIMA PRIYADHARSHINI J
56	411516106046	PRAVEEN U.
57	411516106047	PRAVEEN.R.S.NAIR R.S
58	411516106059	SUBHASH S
59	411516106060	SUDHAKARAN G.
60	411516106061	SURYA PRAKASH K
61	411516106063	VAIRAMUTHU K
62	411516106065	VIJAYA SUNDARAM A.G
63	411516106066	VIMAL KUMAR R
64	411516106067	VIMAL KUMAR S
65	411516106069	VISHALI K.
66	411516106070	YOGESHWAR S
67	411516106304	SASI KUMAR M

PERI INSTITUTE OF TECHNOLOGY
DEPARTMENT OF ECE
ACADEMIC YEAR 2018-2019
IV/ECE

S.NO.	REG. NO	STUDENT NAME
1	411515106001	ABDUL HAI H
2	411515106002	ABINESH D
3	411515106003	ABINESH AYJITH R C
4	411515106004	ABIRAMI A
5	411515106005	AJAY SOBI S
6	411515106006	AKSHARAKAIRALI
7	411515106007	ANNES FATHIMA A
8	411515106008	ARULJOTHI N
9	411515106009	ASHIQ MOHAMMED M
10	411515106010	BANU PRIYA M
11	411515106011	BAWYA M
12	411515106012	BHAVANI D
13	411515106013	BHEEMA NASRIN
14	411515106014	CHARUMATHI T
15	411515106015	DEEPIKA S
16	411515106016	DEEPTHI K
17	411515106017	DEERAJ MANJARAY R
18	411515106019	DINESH A
19	411515106020	GANESH KUMAR K
20	411515106021	GOKUL KRISHNAN C
21	411515106022	GOKULA RAJA K
22	411515106024	HEMAMALINI D

**PERI INSTITUTE OF TECHNOLOGY
DEPARTMENT OF ECE
ACADEMIC YEAR 2018-2019
IV/ECE**

23	411515106025	INDRA D
24	411515106026	JAYASHREE S
25	411515106027	JAYASHREE R
26	411515106028	JOHN DIWAKAR S
27	411515106029	KALAIARASI J
28	411515106030	KAMINI D
29	411515106031	KARTHIKEYAN D
30	411515106032	KARTHIKEYAN R
31	411515106033	KATHERIN S
32	411515106034	KAVIYA E
33	411515106035	KEERTHIGA R
34	411515106036	KEERTHIKA P
35	411515106037	KISHORE B
36	411515106038	KISHORE S
37	411515106039	KRISHNA S
38	411515106040	KUMARAN P
39	411515106041	LAVANYA A
40	411515106042	MADHAN KUMAR S
41	411515106043	MANIKANDAN B
42	411515106044	MANIKANDAN S
43	411515106045	MUTHARASI A M
44	411515106046	MYTHILY
45	411515106047	NAGANANDHINI G

**PERI INSTITUTE OF TECHNOLOGY
DEPARTMENT OF ECE
ACADEMIC YEAR 2018-2019
IV/ECE**

46	411515106049	NAUFAL MOHAMMED HABI B
47	411515106050	NAVEEN KUMAR R
48	411515106051	NIKITHA R
49	411515106052	NIVEDHA L
50	411515106053	NIVETHA JENIFER
51	411515106054	PARTHIBAN GANGAA
52	411515106055	PERIYANAYAKI G
53	411515106056	PONSELVAPRIYA B
54	411515106057	PRADEEPA E
55	411515106058	PRADEEPA P
56	411515106059	PRAKASH M (07.08.1997)
57	411515106061	PRAVALIKA P
58	411515106062	PRAVIN JYOTI B
59	411515106063	PRIYADHARSHNI T
60	411515106064	PRIYANGA G
61	411515106065	PRIYANKA P
62	411515106066	RAGUL S
63	411515106067	RAJKUMAR M
64	411515106068	RAMYA V
65	411515106069	RANJITH S
66	411515106070	SASHIKUMAR R
67	411515106071	SETHUPATHY S

**PERI INSTITUTE OF TECHNOLOGY
DEPARTMENT OF ECE
ACADEMIC YEAR 2018-2019
IV/ECE**

68	411515106072	SHARMILA C
69	411515106074	SINDHUJOTHI R
70	411515106075	SIRAJUDDIN G
71	411515106076	SIVAKUMAR G
72	411515106078	SOWMIYA S
73	411515106079	SRI DEVI M
74	411515106080	SRINITHI K
75	411515106081	STEPHEN R
76	411515106084	VIGNESH G
77	411515106086	VIJAY K
78	411515106087	VIJAYALAKSHMI
79	411515106088	VINODHA M
80	411515106089	VISHVA NAVEENA M
81	411515106090	YOGESH R
82	411515106301	MOHANA KRISHNAN

PERI INSTITUTE OF TECHNOLOGY

DEPARTMENT OF ECE

Attendance sheet for Embedded building blocks using Arduino

S.NO	REG. NO.	NAME OF THE STUDENT	07.07.18	09.07.18	10.07.18	11.07.18	12.07.18	13.07.18
1	411515106001	Abdul Hai H	Abdul Hai H	Abdul Hai H	Abdul Hai H	Abdul Hai H	Abdul Hai H	Abdul Hai H
2	411515106002	Abinesh D	Abinesh D	Abinesh D	AB	Abinesh D	Abinesh D	Abinesh D
3	411515106003	Abinesh Ayjith R C	Abinesh Ayjith R C	Abinesh Ayjith R C	AB	Abinesh Ayjith R C	Abinesh Ayjith R C	Abinesh Ayjith R C
4	411515106004	Abirami A	Abirami A	Abirami A	Abirami A	Abirami A	Abirami A	Abirami A
5	411515106005	Ajay Sobi S	Ajay Sobi S	Ajay Sobi S	Ajay Sobi S	Ajay Sobi S	Ajay Sobi S	Ajay Sobi S
6	411515106006	Aksharakairali	Aksharakairali	Aksharakairali	Aksharakairali	Aksharakairali	Aksharakairali	Aksharakairali
7	411515106007	Annes Fathima A	Annes Fathima A	Annes Fathima A	Annes Fathima A	Annes Fathima A	Annes Fathima A	Annes Fathima A
8	411515106008	Aruljothi N	Aruljothi N	Aruljothi N	Aruljothi N	Aruljothi N	Aruljothi N	Aruljothi N
9	411515106009	Ashiq Mohammed M	Ashiq Mohammed M	Ashiq Mohammed M	Ashiq Mohammed M	Ashiq Mohammed M	Ashiq Mohammed M	AB
10	411515106010	Banu Priya M	Banu Priya M	Banu Priya M	Banu Priya M	Banu Priya M	Banu Priya M	Banu Priya M
11	411515106011	Bawya M	Bawya M	Bawya M	Bawya M	Bawya M	Bawya M	Bawya M
12	411515106012	Bhavani D	Bhavani D	Bhavani D	Bhavani D	Bhavani D	Bhavani D	Bhavani D
13	411515106013	Bheema Nasrin	Bheema Nasrin	AB	AB	Bheema Nasrin	Bheema Nasrin	Bheema Nasrin
14	411515106014	Charumathi T	Charumathi T	Charumathi T	Charumathi T	Charumathi T	Charumathi T	Charumathi T
15	411515106015	Deepika S	Deepika S	Deepika S	Deepika S	Deepika S	Deepika S	Deepika S
16	411515106016	Deepthi K	Deepthi K	Deepthi K	Deepthi K	Deepthi K	Deepthi K	Deepthi K
17	411515106017	Deeraj Manjaray R	Deeraj Manjaray R	Deeraj Manjaray R	Deeraj Manjaray R	Deeraj Manjaray R	Deeraj Manjaray R	Deeraj Manjaray R
18	411515106019	Dinesh A	Dinesh A	Dinesh A	Dinesh A	Dinesh A	Dinesh A	Dinesh A
19	411515106020	Ganesh Kumar K	Ganesh Kumar K	AB	Ganesh Kumar K	AB	Ganesh Kumar K	AB
20	411515106021	Gokul Krishnan C	Gokul Krishnan C	Gokul Krishnan C	Gokul Krishnan C	Gokul Krishnan C	Gokul Krishnan C	AB
21	411515106022	Gokula Raja K	Gokula Raja K	Gokula Raja K	Gokula Raja K	Gokula Raja K	Gokula Raja K	Gokula Raja K
22	411515106024	Hemamalini D	Hemamalini D	Hemamalini D	Hemamalini D	Hemamalini D	Hemamalini D	Hemamalini D
23	411515106025	Indra D	Indra D	Indra D	Indra D	Indra D	Indra D	Indra D
24	411515106026	Jayashree S	Jayashree S	Jayashree S	Jayashree S	Jayashree S	Jayashree S	Jayashree S
25	411515106027	Jayashree R	Jayashree R	Jayashree R	Jayashree R	Jayashree R	Jayashree R	Jayashree R
26	411515106028	John Diwakar S	John Diwakar S	John Diwakar S	John Diwakar S	John Diwakar S	John Diwakar S	John Diwakar S
27	411515106029	Kalairasi J	Kalairasi J	Kalairasi J	Kalairasi J	Kalairasi J	Kalairasi J	Kalairasi J
28	411515106030	Kamini D	Kamini D	Kamini D	Kamini D	Kamini D	Kamini D	Kamini D

29	411515106031	Karthikeyan D	Karthikeyan D	Karthikeyan D	Karthikeyan D	AB	Karthikeyan D
30	411515106032	Karthikeyan R	AB	Karthikeyan R	AB	AB	Karthikeyan R
31	411515106033	Katherin S	Katherin S	Katherin S	Katherin S	Katherin S	Katherin S
32	411515106034	Kaviya E	Kaviya	Kaviya	Kaviya	Kaviya	Kaviya
33	411515106035	Keerthiga R	Keerthiga R	Keerthiga R	Keerthiga R	Keerthiga R	Keerthiga R
34	411515106036	Keerthika P	Keerthika P	Keerthika P	Keerthika P	Keerthika P	Keerthika P
35	411515106037	Kishore B	Kishore B	Kishore B	Kishore B	Kishore B	Kishore B
36	411515106038	Kishore S	Kishore S	Kishore S	Kishore S	Kishore S	Kishore S
37	411515106039	Krishna S	Krishna S	AB	Krishna S	Krishna S	Krishna S
38	411515106040	Kumaran P	Kumaran P	AB	Kumaran P	Kumaran P	Kumaran P
39	411515106041	Lavanya A	Lavanya A	Lavanya A	Lavanya A	Lavanya A	Lavanya A
40	411515106042	Madhan Kumar S	Madhan Kumar S	Madhan Kumar S	Madhan Kumar S	Madhan Kumar S	Madhan Kumar S
41	411515106043	Manikandan B	Manikandan B	Manikandan B	Manikandan B	Manikandan B	Manikandan B
42	411515106044	Manikandan S	Manikandan S	AB	Manikandan S	Manikandan S	Manikandan S
43	411515106045	Mutharasi A M	Mutharasi A M	Mutharasi A M	Mutharasi A M	Mutharasi A M	Mutharasi A M
44	411515106046	Mythily	Mythily	Mythily	Mythily	Mythily	Mythily
45	411515106047	Naganandhini G	Naganandhini G	Naganandhini G	Naganandhini G	Naganandhini G	Naganandhini G
46	411515106049	Naufal Mohammed Habi B	AB	Naufal Mohammed Habi B	Naufal Mohammed Habi B	AB	Naufal Mohammed Habi B
47	411515106050	Naveen Kumar R	Naveen Kumar R	Naveen Kumar R	Naveen Kumar R	AB	Naveen Kumar R
48	411515106051	Nikitha R	Nikitha R	Nikitha R	Nikitha R	Nikitha R	Nikitha R
49	411515106052	Nivedha L	Nivedha L	Nivedha L	Nivedha L	Nivedha L	Nivedha L
50	411515106053	Nivetha Jenifer	Nivetha Jenifer	Nivetha Jenifer	Nivetha Jenifer	Nivetha Jenifer	Nivetha Jenifer
51	411515106054	Parthiban Gangaa	Parthiban Gangaa	Parthiban Gangaa	Parthiban Gangaa	AB	Parthiban Gangaa
52	411515106055	Periyanyaki G	Periyanyaki G	Periyanyaki G	Periyanyaki G	Periyanyaki G	Periyanyaki G
53	411515106056	Ponselvapriya B	Ponselvapriya B	Ponselvapriya B	Ponselvapriya B	Ponselvapriya B	Ponselvapriya B
54	411515106057	Pradeepa E	Pradeepa E	Pradeepa E	Pradeepa E	Pradeepa E	Pradeepa E
55	411515106058	Pradeepa P	Pradeepa P	Pradeepa P	Pradeepa P	Pradeepa P	Pradeepa P
56	411515106059	Prakash M (07.08.1997)	Prakash M (07.08.1997)	AB	Prakash M (07.08.1997)	AB	Prakash M (07.08.1997)
57	411515106061	Pravalika P	Pravalika P	Pravalika P	Pravalika P	Pravalika P	Pravalika P
58	411515106062	Pravin Jyoti B	AB	Pravin Jyoti B	Pravin Jyoti B	Pravin Jyoti B	Pravin Jyoti B
59	411515106063	Priyadarshni T	Priyadarshni T	Priyadarshni T	Priyadarshni T	Priyadarshni T	Priyadarshni T
60	411515106064	Priyanga G	Priyanga G	Priyanga G	Priyanga G	Priyanga G	Priyanga G
61	411515106065	Priyanka P	Priyanka P	Priyanka P	Priyanka P	Priyanka P	Priyanka P

62	411515106066	Ragul S	Ragul	Ragul	Ragul	Ragul	Ragul	Ragul
63	411515106067	Rajkumar M	Rajkumar M	Rajkumar M	Rajkumar M	Rajkumar M	Rajkumar M	Rajkumar M
64	411515106068	Ramya V	Ramya V	Ramya V	Ramya V	Ramya V	Ramya V	Ramya V
65	411515106069	Ranjith S	Ranjith S	Ranjith S	Ranjith S	Ranjith S	Ranjith S	Ranjith S
66	411515106070	Sashikumar R	Sashikumar R	Sashikumar R	Sashikumar R	Sashikumar R	Sashikumar R	Sashikumar R
67	411515106071	Sethupathy S	Sethupathy S	Sethupathy S	Sethupathy S	Sethupathy S	Sethupathy S	Sethupathy S
68	411515106072	Sharmila C	Sharmila C	Sharmila C	Sharmila C	Sharmila C	Sharmila C	Sharmila C
69	411515106074	Sindhujothi R	Sindhujothi R	Sindhujothi R	Sindhujothi R	Sindhujothi R	Sindhujothi R	Sindhujothi R
70	411515106075	Sirajuddin G	Sirajuddin G	Sirajuddin G	Sirajuddin G	Sirajuddin G	Sirajuddin G	Sirajuddin G
71	411515106076	Sivakumar G	Sivakumar G	Sivakumar G	Sivakumar G	Sivakumar G	Sivakumar G	Sivakumar G
72	411515106078	Sowmiya S	Sowmiya S	Sowmiya S	Sowmiya S	Sowmiya S	Sowmiya S	Sowmiya S
73	411515106079	Sri Devi M	Sri Devi M	Sri Devi M	Sri Devi M	Sri Devi M	Sri Devi M	Sri Devi M
74	411515106080	Srinithi K	Srinithi K	Srinithi K	Srinithi K	Srinithi K	Srinithi K	Srinithi K
75	411515106081	Stephen R	Stephen R	Stephen R	Stephen R	Stephen R	Stephen R	Stephen R
76	411515106084	Vignesh G	Vignesh G	Vignesh G	Vignesh G	Vignesh G	Vignesh G	Vignesh G
77	411515106086	Vijay K	Vijay K	Vijay K	Vijay K	Vijay K	Vijay K	Vijay K
78	411515106087	Vijayalakshmi	Vijayalakshmi	Vijayalakshmi	Vijayalakshmi	Vijayalakshmi	Vijayalakshmi	Vijayalakshmi
79	411515106088	Vinodha M	Vinodha M	Vinodha M	Vinodha M	Vinodha M	Vinodha M	Vinodha M
80	411515106089	Vishva Naveena M	Vishva Naveena M	Vishva Naveena M	Vishva Naveena M	Vishva Naveena M	Vishva Naveena M	Vishva Naveena M
81	411515106090	Yogesh R	Yogesh R	Yogesh R	Yogesh R	Yogesh R	Yogesh R	Yogesh R
82	411515106301	Mohana Krishnan	Mohana Krishnan	Mohana Krishnan	Mohana Krishnan	Mohana Krishnan	Mohana Krishnan	Mohana Krishnan
PRESENT			79	78	76	79	78	78
ABSENT			03	04	06	03	04	04

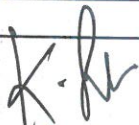
Coordinator

HOD/ECE

PERI INSTITUTE OF TECHNOLOGY

DEPARTMENT OF ECE

Attendance sheet for Embedded building blocks using Arduino

S.NO	REG. NO.	NAME OF THE STUDENT	07.07.18	09.07.18	10.07.18	11.07.18	12.07.18	13.07.18
1	411516106003	Annie Muthabaranam A	Annie.A	Annie.A	Annie.A	Annie.A	Annie.A	Annie.A
2	411516106005	Arshad Ahmed M D	AA	AA	AA	AA	AA	AA
3	411516106006	Arul Kumar S	AK	AK	AK	AK	AK	AK
4	411516106010	Asraf A.	AA	AA	AA	AA	AA	AA
5	411516106012	Bhuvanaa C.	Bhuc.C	Bhuc.C	Bhuc.C	Bhuc.C	Bhuc.C	Bhuc.C
6	411516106013	Daniel Ancing E	D	D	D	D	D	D
7	411516106015	Devanand M.	DM	DM	DM	DM	DM	DM
8	411516106022	Iyyanarappan M	IM	IM	IM	IM	IM	IM
9	411516106023	Jacklin Emilda S.	JS	JS	JS	JS	JS	JS
10	411516106026	Jayashree S.	Jaysh	Jaysh	Jaysh	Jaysh	Jaysh	Jaysh
11	411516106027	Keerthana C.K	KK	KK	KK	KK	KK	KK
12	411516106028	Keshav Kumar J.	KK	KK	KK	KK	KK	KK
13	411516106029	Kirthika S.	Krithi.S	Krithi.S	Krithi.S	Krithi.S	Krithi.S	Krithi.S
14	411516106032	Lokeshwaran B.	Lokesh	Lokesh	Lokesh	Lokesh	Lokesh	Lokesh
15	411516106033	Mahendra A	MA	MA	MA	MA	MA	MA
16	411516106034	Mahesh Kumar G	Mah.ku	Mah.ku	Mah.ku	Mah.ku	Mah.ku	Mah.ku
17	411516106035	Malathy T.	MT	MT	MT	MT	MT	MT
18	411516106037	Manju Bharkavi M	Mah.ku	Mah.ku	Mah.ku	Mah.ku	Mah.ku	Mah.ku
19	411516106038	Maria Theena L.T	Maria	Maria	Maria	Maria	Maria	Maria
20	411516106041	Nivas A.T	Nivas	Nivas	Nivas	Nivas	Nivas	Nivas
21	411516106042	Nivetha J.	Nivi	Nivi	Nivi	Nivi	Nivi	Nivi
22	411516106043	Nivetha M	Nivi	Nivi	Nivi	Nivi	Nivi	Nivi
23	411516106044	Pavithra R	Pan	Pan	Pan	Pan	Pan	Pan
24	411516106048	Prethi Sai L.	P.Sai	P.Sai	P.Sai	P.Sai	P.Sai	P.Sai
25	411516106049	Radhika G	Radhika	Radhika	Radhika	Radhika	Radhika	Radhika
26	411516106050	Ragini J	Raji	Raji	Raji	Raji	Raji	Raji
27	411516106051	Rajesh S	Rajesh	Rajesh	Rajesh	Rajesh	Rajesh	Rajesh
28	411516106052	Ramya S	Ramya.S	Ramya.S	Ramya.S	Ramya.S	Ramya.S	Ramya.S

29	411516106053	Ranjith Sreekar A.G	Pa	AB	AB	AB	Re	Re
30	411516106054	Riyaz Ahamed A	Riyaz	Riyaz	Riyaz	Riyaz	Riyaz	Riyaz
31	411516106055	Sandhya M	Sandhya	Sandhya	Sandhya	Sandhya	Sandhya	Sandhya
32	411516106056	Santhosh M	Santhosh	Santhosh	Santhosh	Santhosh	Santhosh	Santhosh
33	411516106057	Shivali Angral	Shivali	Shivali	Shivali	Shivali	Shivali	Shivali
34	411516106058	Sowmya S.	Sowmya	Sowmya	Sowmya	Sowmya	Sowmya	Sowmya
35	411516106062	Uma Shankar R	Uma	Uma	Uma	Uma	Uma	Uma
36	411516106064	Vignesh N.	Vignesh	Vignesh	Vignesh	Vignesh	Vignesh	Vignesh
37	411516106301	Bhavana T	Bhavana	Bhavana	Bhavana	Bhavana	Bhavana	Bhavana
38	411516106302	Kanchana A	Kanchana	Kanchana	Kanchana	Kanchana	Kanchana	Kanchana
39	411516106303	Koyalamudi Sai Krishna	Koyalam	Koyalam	Koyalam	Koyalam	Koyalam	Koyalam
40	411516106307	Yuvanshankar P.D	Yuvan	Yuvan	Yuvan	Yuvan	Yuvan	Yuvan
41	411516106701	Achanta Trinadh Kumar A	Achanta	Achanta	Achanta	Achanta	Achanta	Achanta
42	411516106001	Akash B.	Akash	Akash	Akash	Akash	Akash	Akash
43	411516106008	Arunachalam K	Arunachalam	Arunachalam	Arunachalam	Arunachalam	Arunachalam	Arunachalam
44	411516106009	Asif Ali A	Asif Ali	Asif Ali	Asif Ali	Asif Ali	Asif Ali	Asif Ali
45	411516106011	Balaji K	Balaji	Balaji	Balaji	Balaji	Balaji	Balaji
46	411516106014	Deen Kumaran V	Deen	Deen	Deen	Deen	Deen	Deen
47	411516106016	Dilip Kumar T.	Dilip	Dilip	Dilip	Dilip	Dilip	Dilip
48	411516106018	Gowri S.	Gowri	Gowri	Gowri	Gowri	Gowri	Gowri
49	411516106019	Hariharan C	Hariharan	Hariharan	Hariharan	Hariharan	Hariharan	Hariharan
50	411516106021	Henry Solomon J	Henry	Henry	Henry	Henry	Henry	Henry
51	411516106024	Jagan L.	Jagan	Jagan	Jagan	Jagan	Jagan	Jagan
52	411516106025	Jai Prakash V.	Jai Prakash	Jai Prakash	Jai Prakash	Jai Prakash	Jai Prakash	Jai Prakash
53	411516106030	Kirubhakaran M.	Kirubhakaran	Kirubhakaran	Kirubhakaran	Kirubhakaran	Kirubhakaran	Kirubhakaran
54	411516106040	Naveenkumar V	Naveenkumar	Naveenkumar	Naveenkumar	Naveenkumar	Naveenkumar	Naveenkumar
55	411516106045	Poornima Priyadarshini J	Poornima	Poornima	Poornima	Poornima	Poornima	Poornima
56	411516106046	Praveen U.	Praveen	Praveen	Praveen	Praveen	Praveen	Praveen
57	411516106047	Praveen.R.S.Nair R.S	Praveen	Praveen	Praveen	Praveen	Praveen	Praveen
58	411516106059	Subhash S	Subhash	Subhash	Subhash	Subhash	Subhash	Subhash
59	411516106060	Sudhakaran G.	Sudhakaran	Sudhakaran	Sudhakaran	Sudhakaran	Sudhakaran	Sudhakaran
60	411516106061	Surya Prakash K	Surya	Surya	Surya	Surya	Surya	Surya
61	411516106063	Vairamuthu k	Vairamuthu	Vairamuthu	Vairamuthu	Vairamuthu	Vairamuthu	Vairamuthu

62	411516106065	Vijaya Sundaram A.G	Present	Present	Present	Present	Present	Present
63	411516106066	Vimal Kumar R	Vimal Kumar R	Vimal Kumar R	Vimal Kumar R	Vimal Kumar R	Vimal Kumar R	Vimal Kumar R
64	411516106067	Vimal Kumar S	Vimal Kumar S	Vimal Kumar S	Vimal Kumar S	Vimal Kumar S	Vimal Kumar S	Vimal Kumar S
65	411516106069	Vishali K.	Vishali K.	Vishali K.	Vishali K.	Vishali K.	Vishali K.	Vishali K.
66	411516106070	Yogeshwar S	Yogeshwar S	Yogeshwar S	Yogeshwar S	Yogeshwar S	Yogeshwar S	Yogeshwar S
67	411516106304	Sasi Kumar M	Sasi Kumar M	Sasi Kumar M	Sasi Kumar M	Sasi Kumar M	Sasi Kumar M	Sasi Kumar M
PRESENT			67	66	66	66	67	67
ABSENT			-	01	01	01	-	-

Coordinator

HOD/ECE

5

PERI INSTITUTE OF TECHNOLOGY
DEPARTMENT OF ECE
Attendance sheet for Embedded building blocks using Arduino

S.NO	REG. NO.	NAME OF THE STUDENT	07.07.18	09.07.18	10.07.18	11.07.18	12.07.18	13.07.18
1	411517106001	Aakash C.S	Aakash	Aakash	Aakash	Aakash	Aakash	Aakash C
2	411517106002	Aakash Raj S	Aakash	Aakash	Aakash	Aakash	Aakash	Aakash
3	411517106003	Abdulla A	Abdulla	Abdulla	Abdulla	Abdulla	Abdulla	Abdulla
4	411517106004	Agnisha V.	Agnisha	Agnisha	Agnisha	Agnisha	Agnisha	Agnisha
5	411517106005	Aileen Mercybell A	Aileen	Aileen	Aileen	Aileen	Aileen	Aileen A
6	411517106006	Akash S	Akash	Akash	Akash	Akash	Akash	Akash
7	411517106008	Annapureddy Dhana Lakshmi A	Annapureddy	Annapureddy	Annapureddy	Annapureddy	Annapureddy	Annapureddy
8	411517106009	Arasavalli Teja Durga Sai S.	Arasavalli	Arasavalli	Arasavalli	Arasavalli	Arasavalli	Arasavalli
9	411517106010	Arun K.S.	Arun	Arun	Arun	Arun	Arun	Arun
10	411517106011	Aruneshwaran M	Aruneshwaran	Aruneshwaran	Aruneshwaran	Aruneshwaran	Aruneshwaran	Aruneshwaran
11	411517106012	Ashika K	Ashika	Ashika	Ashika	Ashika	Ashika	Ashika
12	411517106013	Balaji N	Balaji	Balaji	Balaji	Balaji	Balaji	Balaji
13	411517106014	Vamsi Krishna B.	Vamsi	Vamsi	Vamsi	Vamsi	Vamsi	Vamsi
14	411517106015	Bharath Balaji R	Bharath	Bharath	Bharath	Bharath	Bharath	Bharath
15	411517106016	Boya Venkata Rakesh B.	Boya Venkata	Boya Venkata	Boya Venkata	Boya Venkata	Boya Venkata	Boya Venkata
16	411517106018	Chintala.Supriya S.	Chintala	Chintala	Chintala	Chintala	Chintala	Chintala
17	411517106019	Chukka Monica B.	Chukka	Chukka	Chukka	Chukka	Chukka	Chukka
18	411517106020	Deepika M.	Deepika	Deepika	Deepika	Deepika	Deepika	Deepika
19	411517106021	Delli Ganesh G	Delli	Delli	Delli	Delli	Delli	Delli
20	411517106022	Dinesh V	Dinesh	Dinesh	Dinesh	Dinesh	Dinesh	Dinesh
21	411517106023	Divya Priya R.	Divya	Divya	Divya	Divya	Divya	Divya
22	411517106024	Euro Sri M.	Euro	Euro	Euro	Euro	Euro	Euro
23	411517106025	Gadikota Deekshitha G.	Gadikota	Gadikota	Gadikota	Gadikota	Gadikota	Gadikota
24	411517106026	Gadi Mano Varshith G.	Gadi Mano	Gadi Mano	Gadi Mano	Gadi Mano	Gadi Mano	Gadi Mano
25	411517106027	Ganesh Karan K	Ganesh	Ganesh	Ganesh	Ganesh	Ganesh	Ganesh
26	411517106028	Gayathri K	Gayathri	Gayathri	Gayathri	Gayathri	Gayathri	Gayathri
27	411517106029	Gnanaprasath L	Gnanaprasath	Gnanaprasath	Gnanaprasath	Gnanaprasath	Gnanaprasath	Gnanaprasath
28	411517106030	Gupendhiran S	Gupendhiran	Gupendhiran	Gupendhiran	Gupendhiran	Gupendhiran	Gupendhiran

29	411517106031	Gurrala Hari R.	Hari	Hari	Hari	Hari	Hari	Hari	Hari
30	411517106032	Gurudharsan B	Guruf	Guruf	Gurud	Guruf	Guruf	Guruf	Guruf
31	411517106033	Hariharan K	Harhu	Harhu	Harhu	Harhu	Harhu	Harhu	Harhu
32	411517106034	Haripriya B.	Haripriya	Haripriya	Haripriya	Haripriya	Haripriya	Haripriya	Haripriya
33	411517106035	Ilango M	Ilang	Ilang	Ilang	Ilang	Ilang	Ilang	Ilang
34	411517106036	Jaiganesh S	Jai Ganesh	Jai Ganesh	Jai Ganesh	Jai Ganesh	Jai Ganesh	Jai Ganesh	Jai Ganesh
35	411517106038	Javangula Manichand J	Java. J	Java. J	Java. J	Java. J	Java. J	Java. J	Java. J
36	411517106040	Jothika A	J	J	J	J	J	J	J
37	411517106041	Kalaivani K	Kalaivani	Kalaivani	Kalaivani	Kalaivani	Kalaivani	Kalaivani	Kalaivani
38	411517106042	Kamaleeshwar M	Kamaleeshwar	Kamaleeshwar	Kamaleeshwar	Kamaleeshwar	Kamaleeshwar	Kamaleeshwar	Kamaleeshwar
39	411517106043	Kamesh M	Kamesh M	AB	AB	M. Kamesh	M. Kamesh	M. Kamesh	M. Kamesh
40	411517106044	Kamesh R	Kamesh R	AB	AB	Kamesh R	AB	Kamesh R	Kamesh R
41	411517106045	Kanickai Raj J	AB	AB	Kanj. J	Kanj. K	Kanj. K	Kanj. K	Kanj. K
42	411517106046	Karthic B	Karthic	Karthic	Karthic	Karthic	Karthic	Karthic	Karthic
43	411517106047	Karthikeyan A	Karthi	Karthi	Karthi	Karthi	Karthi	Karthi	Karthi
44	411517106048	Kathiravan G	Kathiravan	G. Kathiravan	G. Kathiravan	AB	G. Kathiravan	G. Kathiravan	G. Kathiravan
45	411517106049	Kavin J	Kavin	Kavin	Kavin	Kavin	Kavin	Kavin	Kavin
46	411517106051	Keerthana L	K	K	K	K	K	K	K
47	411517106052	Keerthi Rajan A.S	Keerthi Rajan	Keerthi	AB	AB	Keerthi	Keerthi	Keerthi
48	411517106053	Sasidhar Naidu K	Sasidhar	Sasidhar	Sasidhar	Sasidhar	Sasidhar	Sasidhar	Sasidhar
49	411517106054	Kishore Kumar M	Kishore	Kishore	Kishore	Kishore	Kishore	Kishore	Kishore
50	411517106056	Krishnaraj V	Krishna. V	Krishna. V	Krishna. V	Krishna. V	Krishna. V	Krishna. V	Krishna. V
51	411517106057	Kumaran J	Kumaran. J	AB	AB	Kumaran. J	Kumaran. J	Kumaran. J	Kumaran. J
52	411517106058	Lakshmi Aishwarya R.	Lakshmi	Lakshmi	Lakshmi	Lakshmi	AB	AB	AB
53	411517106059	Leena S	Leena	Leena	Leena	Leena	Leena	Leena	Leena
54	411517106060	Logesh S	Logesh	Logesh	Logesh	Logesh	Logesh	Logesh	Logesh
55	411517106061	Logeshwari G.	Logeshwari	Logeshwari	AB	AB	Logeshwari	Logeshwari	Logeshwari
56	411517106062	Lokeshkumar M.	Lokeshkumar	AB	AB	Lokeshkumar	Lokeshkumar	Lokeshkumar	Lokeshkumar
57	411517106063	Lokesh Kumar G	Lokesh	Lokesh	Lokesh	Lokesh	Lokesh	Lokesh	AB
58	411517106064	Lokeshwaran P	AB	AB	Lokesh	Lokesh	Lokesh	Lokesh	AB
59	411517106065	Madhan Raj P.	Madhan	Madhan	Madhan	Madhan	Madhan	Madhan	AB
60	411517106066	Manibharathi S.	Mani	Mani	Mani	Mani	Mani	Mani	Mani
61	411517106067	Manisha V.	Manish	Manish	Manish	Manish	Manish	Manish	Manish

62	411517106068	Mary K	Mary	AB	AB	Mary	Mary	Mary
63	411517106069	Mohammed Shaarif K	Moh Shaarik	Moh Shaarik	Moh Shaarik	Moh Shaarik	Moh Shaarik	Moh Shaarik
64	411517106070	Mohana N	Mohana	Mohana	Mohana	Mohana	Mohana	Mohana
65	411517106071	Monisha M.	Monish	Monish	Monish	Monish	Monish	Monish
66	411517106072	Kranthi Kumar N	Kranthi	Kranthi	Kranthi	Kranthi	Kranthi	Kranthi
67	411517106076	Kiran Kumar Reddy O.	Kiran	Kiran	Kiran	Kiran	Kiran	Kiran
68	411517106077	Padmashree M.	Padma	Padma	Padma	Padma	Padma	Padma
69	411517106079	Pradeep K.V	Pradeep	Pradeep	Pradeep	Pradeep	Pradeep	Pradeep
70	411517106081	Praveen S	Praveen	Praveen	Praveen	Praveen	Praveen	Praveen
71	411517106082	Ragavender S	Ragav	Ragav	Ragav	Ragav	Ragav	Ragav
72	411517106083	Raja Shree B	Raja	Raja	Raja	Raja	Raja	Raja
73	411517106084	Rakini C.	Rakini	Rakini	Rakini	Rakini	Rakini	Rakini
74	411517106085	Ramaprakash G.	Ramprakash	Ramprakash	Ramprakash	Ramprakash	Ramprakash	Ramprakash
75	411517106086	Raveen Kumar M	Raveen	Raveen	Raveen	Raveen	Raveen	Raveen
76	411517106087	Rupa Sri V M	Rupa	Rupa	Rupa	Rupa	Rupa	Rupa
77	411517106088	Sai Sruthi K	Sai	Sai	Sai	Sai	Sai	Sai
78	411517106089	Sandhiya V	Sandhya	Sandhya	Sandhya	Sandhya	Sandhya	Sandhya
79	411517106090	Sanjay S	Sanjay	Sanjay	Sanjay	Sanjay	Sanjay	Sanjay
80	411517106091	Santhana Karthick D	S.Karthick	S.Karthick	S.Karthick	S.Karthick	S.Karthick	S.Karthick
81	411517106092	Selva Dharshini V	Selva	Selva	Selva	Selva	Selva	Selva
82	411517106093	Selva Sooriya S	Selva	Selva	Selva	Selva	Selva	Selva
83	411517106094	Shanthi V.	Shanthi	Shanthi	Shanthi	Shanthi	Shanthi	Shanthi
84	411517106095	Sharon Grace Betsy G	Sharon	Sharon	Sharon	Sharon	Sharon	Sharon
85	411517106096	Sheshi Kumar G.R	Sheshi	Sheshi	Sheshi	Sheshi	Sheshi	Sheshi
86	411517106097	Shivahari P	Shiv	Shiv	Shiv	Shiv	Shiv	Shiv
87	411517106098	Siva Kumar S	Siva	Siva	Siva	Siva	Siva	Siva
88	411517106099	Siva Saravanan K	Siva	Siva	Siva	Siva	Siva	Siva
89	411517106101	Sriram E.	Sriram	Sriram	Sriram	Sriram	Sriram	Sriram
90	411517106102	Subalakshmi H	Suba	Suba	Suba	Suba	Suba	Suba
91	411517106104	Uma Magheswari K	Uma	Uma	Uma	Uma	Uma	Uma
92	411517106105	Yamini Chowdary U	Yamini	Yamini	Yamini	Yamini	Yamini	Yamini
93	411517106106	Vallarasu R	Vallarasu	Vallarasu	Vallarasu	Vallarasu	Vallarasu	Vallarasu
94	411517106107	Vasanth kumar.K	V.K.kumar	V.K.kumar	V.K.kumar	V.K.kumar	V.K.kumar	V.K.kumar

95	411517106108	Vignesh A	vignesh A	vignesh A	vignesh A	vignesh A	vignesh A	vignesh A
96	411517106109	Vignesh P	vignesh P	vignesh P	vignesh P	vignesh P	vignesh P	vignesh P
97	411517106110	Vijayalakshmi G	Vijayalakshmi G	Vijayalakshmi G	Vijayalakshmi G	Vijayalakshmi G	Vijayalakshmi G	Vijayalakshmi G
98	411517106111	Vijithra V	Vijithra V	Vijithra V	Vijithra V	Vijithra V	Vijithra V	Vijithra V
99	411517106112	Vinodhini S	Vinodhini S	Vinodhini S	Vinodhini S	Vinodhini S	Vinodhini S	Vinodhini S
100	411517106113	Vunnam Sucharitha V.	Vunnam Sucharitha V.	Vunnam Sucharitha V.	Vunnam Sucharitha V.	Vunnam Sucharitha V.	Vunnam Sucharitha V.	Vunnam Sucharitha V.
101	411517106114	Yakesh C	Yakesh C	Yakesh C	Yakesh C	Yakesh C	Yakesh C	Yakesh C
102	411517106115	Yazhir Arafath A	Yazhir Arafath A	Yazhir Arafath A	Yazhir Arafath A	Yazhir Arafath A	Yazhir Arafath A	Yazhir Arafath A
103	411517106301	Sudalai Muthu	Sudalai Muthu	Sudalai Muthu	Sudalai Muthu	Sudalai Muthu	Sudalai Muthu	Sudalai Muthu
104	411517106302	Surya	Surya	Surya	Surya	Surya	Surya	Surya
105	411517106303	Vignesh . L	vignesh . L	vignesh . L	vignesh . L	vignesh . L	vignesh . L	vignesh . L
PRESENT			103	99	100	102	103	101
ABSENT			02	06	05	03	02	04

K. Ra
Coordinator

Aae
HOD/ECE

[Signature]
Dr. R. PALSON KENNEDY, M.E., Ph.D.,
PRINCIPAL
PERI INSTITUTE OF TECHNOLOGY
Mannivakkam, Chennai - 600 048.

PERI INSTITUTE OF TECHNOLOGY

DEPARTMENT OF ELECTRONICS AND COMMUNICATION ENGINEERING

ASSESSMENT ON EMBEDDED BUILDING BLOCKS USING ARDUINO

1. What is Arduino?

- a) Programming language
- b) Image editing software
- c) Open-source electronics platform
- d) Text editor ✓

2. How many types of Arduino do we have?

- a) 4
- b) 8
- c) 12
- d) 16 ✓

3. What language is a typical Arduino code based on?

- a) Assembly Code
- b) Python ✓
- c) Java
- d) C/C++

4. Arduino shields are also called as _____

- a) Another Arduinos
- b) Extra peripherals ✓
- c) Add on modules
- d) Connectivity modules

5. What language is the Arduino IDE built on?

- a) Java
- b) HTML
- c) C/C++
- d) Python ✓

6. How many analog pins are used in Arduino Mega board?

- a) 12
- b) 16
- c) 8
- d) 19 ✓

7. Arduino IDE consists of 2 functions. What are they?

- a) Loop() and build() and setup()
- b) Build() and loop()

A8
50

Khes

- c) Setup() and build()
- d) Setup() and loop()

8. Arduino Codes are referred to as _____ in the Arduino IDE.

- a) sketches
- b) drawings
- c) links
- d) notes

9. What is the default bootloader of the Arduino UNO?

- a) AIR-boot
- b) GAG
- c) Optiboot bootloader
- d) Bare box

10. What does p refer to in ATmega328p?

- a) Programmable on chip
- b) Power-Pico
- c) Production
- d) Pico-Power

11. What is the use of the Arduino.h header file?

- a) It enables the programmer to access all of Arduino's core functionality
- b) It doesn't have any use and can be omitted at any point of time in the code
- c) It gives root access to the microcontroller's file system
- d) It allows other people to create libraries for the Arduino code

12. What is the use of the Vin pin present on some Arduino Boards?

- a) To ground the Arduino Board
- b) To power the Arduino Board
- c) To provide a 5V output
- d) Is used for plugging in 3V supply

13. What is the correct execution process of an Arduino code?

- a) Editor->Preprocessor->Compiler
- b) Preprocessor->Editor->Compiler
- c) Compiler->Preprocessor->Editor
- d) Editor->Compiler->Preprocessor

14. What is the microcontroller used in Arduino UNO?

- a) ATmega32114
- b) AT91SAM3x8E
- c) ATmega2560
- d) ATmega328p

15. Which board is the first to use a microcontroller within the build USB?

- a) RedBoard
- b) Leonardo
- c) LilyPad
- d) UNO

16. Which Arduino Board contains an onboard joystick?

- a) Arduino Nano
- b) Arduino UNO
- c) Arduino Esplora
- d) Arduino Due

17. What is the function of the IOREF pin on the Arduino UNO?

- a) To take input voltage and set it as a reference for all GPIO operations
- b) To provide a constant 12V DC supply
- c) To provide ground
- d) To provide the voltage corresponding to the standard GPIO working voltage of the board

18. Which processor supports the Arduino Zero?

- a) ARM Cortex M0+
- b) ARM Cortex M3
- c) Atmega32u4
- d) Atmega328P

19. Which software is used to upload the Arduino Sketches to the board?

- a) avrgcc
- b) g++
- c) cpython for windows
- d) avrdude

20. What is the use for the 2 serial pins on the Arduino Diecimila?

- a) To send PWM signals
- b) To send and receive Serial TTL signals
- c) To send and receive GPIO digital signals
- d) To receive analog signals

21. Which Arduino Boards use the Atmega2560?

- a) Arduino Micro and Due
- b) Arduino Nano and Fio
- c) Arduino Mega and Mega ADK
- d) Arduino Uno and Robot

22. What is the operating voltage of Atmega328?

- a) 1.9V to 5V
- b) 1.8V to 5.5V
- c) 1.1V to 5V
- d) 12V to 9V

22. Which Arduino Boards use the Atmega32U4?

- a) Arduino Uno
- b) None Mega
- c) Arduino Micro
- d) Arduino Leonardo

24. Is the Arduino code an Object-Oriented programming language or a Procedural programming language?

- a) The Arduino Code follows the Top-Down Procedural ideology
- b) The Arduino Code follows a custom Procedural Ideology
- c) The Arduino Code follows the Object-Oriented ideology
- d) The Arduino Code follows the Bottom-Up Procedural ideology

25. What is the difference between an IDE and a compiler?

- a) The compiler executes the code while the IDE gives a graphical environment for writing the code
- b) The compiler links the code to the respective files and the IDE takes it from there
- c) The compiler and the IDE are the same thing
- d) The IDE executes the code while the compiler gives a graphical environment for writing the code

26. What will be the output of the following Arduino code?

```
#define X 10;
void setup(){
  X=0;
  Serial.begin(9600);
  Serial.print(X);
}
void loop(){
  //Do nothing...
}
```

- a) 0xAB
- b) 0xa
- c) 0
- d) Error

27. Where does the Arduino IDE search if it needs to find out the Name of a type of Arduino Board?

- a) Arduino.h
- b) build.txt
- c) boards.txt
- d) ~~build~~.core

28. Which component acts as the brain of an embedded system?

- a) The hard drive
- b) The microcontroller
- c) The power supply
- d) ~~The~~ cooling fan

29. What is the primary purpose of an RTOS (Real-Time Operating System) in embedded systems?

- a) ~~To~~ make the system user-friendly
- b) To manage the system's resources efficiently in real-time
- c) To provide internet connectivity
- d) To store large amounts of data

30. What is the primary programming language used in embedded system development?

- a) ~~Python~~
- b) C
- c) Java
- d) HTML

31. Which of the following is an example of an embedded system?

- a) ~~A~~ desktop computer
- b) A digital watch
- c) A word processing software
- d) An online shopping website

32. What is the role of a microcontroller in an embedded system?

- a) To provide a user interface
- b) To connect the system to the internet
- c) ~~To~~ manage the system's resources and processes
- d) To increase the system's storage capacity

33. Which type of memory is primarily used for permanent data storage in embedded systems?

- a) RAM
- b) EEPROM
- c) HDD
- d) Cache

34. What is firmware in the context of embedded systems?

- a) The operating system of a computer
- b) Temporary data stored in RAM
- c) Software that is permanently stored in hardware
- d) A special type of software for developing websites

35. What does RTOS stand for?

- a) Real-Time Operating System
- b) Rapid Transaction Online System
- c) Remote Terminal Operating System
- d) Robust Tools for Operating Systems

36. How do embedded systems typically interact with the external environment?

- a) Through sensors and actuators
- b) By using web browsers
- c) Through human intervention only
- d) By reading and writing data to CDs

37. What role does firmware play in an embedded system?

- a) It acts as a temporary storage area for user data
- b) It provides a graphical user interface
- c) It is the permanently installed software that controls the hardware
- d) It enhances the system's internet connectivity

38. What is the purpose of a watchdog timer in an embedded system?

- a) To track the time of day
- b) To increase system performance
- c) To prevent the system from freezing
- d) To reduce power consumption

39. In embedded systems, what is "power-on reset"?

- a) A procedure to install new software
- b) The process of turning off the device's power supply
- c) A function that initializes system hardware settings to their default state on power-up
- d) A method for reducing power consumption
- c) A function that initializes system hardware settings to their default state on power-up

40. Which communication protocol is commonly used for short-range communication in embedded systems?

- a) Ethernet
- b) Wi-Fi
- c) I2C
- d) LTE

41. What is the function of GPIO in an embedded system?

- a) To increase the processing power
- b) To provide a graphical interface
- c) To manage internet connections
- d) To serve as a generic pin on a chip whose behavior can be controlled by the user at runtime

42. What is pulse width modulation (PWM) commonly used for in embedded systems?

- a) Encrypting data
- b) Managing power supply
- c) Controlling the speed of motors
- d) Storing data

43. What does ADC stand for in the context of embedded systems?

- a) Advanced Data Control
- b) Analog to Digital Converter
- c) Automatic Data Correction
- d) Audio Data Compression

44. Which embedded system component is responsible for executing the instructions of a computer program?

- a) ROM
- b) CPU

- c) RAM
- d) SSD

45. In the context of embedded systems, what is "bus arbitration"?

- a) A method for resolving access conflicts to shared resources
- b) A technique for increasing bus speed
- c) A protocol for secure data transmission
- d) The process of selecting which peripheral to power on

46. What role do capacitors play in embedded system circuits?

- a) To store electric charge
- b) To act as a secondary processor
- c) To increase signal strength
- d) To provide backup power

47. How is SPI different from I2C in embedded systems?

- a) SPI is slower than I2C
- b) SPI is primarily used for internet connectivity
- c) SPI requires more pins for communication than I2C
- d) SPI is less reliable than I2C

48. What is "debouncing" in the context of embedded systems?

- a) Compressing data to save space
- b) Filtering out the noise from a signal
- c) Ensuring a switch or button press is registered as a single action
- d) Reducing the power consumption of a device

49. In embedded systems, what does "bare-metal programming" refer to?

- a) Writing code that runs directly on the hardware without an operating system
- b) Programming with the case of the device removed
- c) Developing software that requires no external libraries
- d) Writing applications that manage their own memory and resources

50. What is the main advantage of using an RTOS in embedded systems?

- a) It allows for easier web development
- b) It provides deterministic behavior and timing
- c) It reduces the need for hardware
- d) It automatically writes code for the developer

PERI INSTITUTE OF TECHNOLOGY
DEPARTMENT OF ELECTRONICS AND COMMUNICATION ENGINEERING
FEEDBACK FORM

ACADEMIC YEAR 2018-2019

Name of the Student: Kishore B Register No: 411515106037
Year: final year Date of Feedback: 13/07/2018
Course Name: Embedded building block using Arduino

1. How do you value the course content?

It is very Understandable

2. How would you understand the content delivery by the instructor?

Instructor is very good in delivering the content

3. Write the overall quality of the program

very good

4. Will you recommend this program to your friends/juniors/seniors?

of course

Suggestions to improve, if any:

nil

Kishore B

Signature of the Student

PERI INSTITUTE OF TECHNOLOGY
DEPARTMENT OF ELECTRONICS AND COMMUNICATION ENGINEERING
FEEDBACK FORM

ACADEMIC YEAR 2018-2019

Name of the Student: *Nivedha L*

Register No: *411515106052*

Year: *final year*

Date of Feedback: *13.7.2018*

Course Name: *Embedded Build blocks using Arduino*

1. How do you value the course content?

In a good way

2. How would you understand the content delivery by the instructor?

Nice

3. Write the overall quality of the program

Nice

4. Will you recommend this program to your friends/juniors/seniors?

Yes

Suggestions to improve, if any:

Nothing

Nivedha
Signature of the Student

PERI INSTITUTE OF TECHNOLOGY
DEPARTMENT OF ELECTRONICS AND COMMUNICATION ENGINEERING
FEEDBACK FORM

ACADEMIC YEAR 2018-2019

Name of the Student: *Abinash . D*

Register No: *415 15 106002*

Year: *final year.*

Date of Feedback: *13/7/2018*

Course Name: *Embedded building block using Arduino*

1. How do you value the course content?

In a good way

2. How would you understand the content delivery by the instructor?

good

3. Write the overall quality of the program

nice

4. Will you recommend this program to your friends/juniors/seniors?

yes

Suggestions to improve, if any: *nothing*

Abinash . D

Signature of the Student

PERI INSTITUTE OF TECHNOLOGY
DEPARTMENT OF ELECTRONICS AND COMMUNICATION ENGINEERING
FEEDBACK FORM

ACADEMIC YEAR 2018-2019

Name of the Student: Bhuvanaa . C

Register No: 411516106012

Year: Third Year

Date of Feedback: 13/07/2018

Course Name: Embedded building blocks using Arduino

1. How do you value the course content?

The value of the course is more interactive.

2. How would you understand the content delivery by the instructor?

Instructor ~~delivers~~ delivers the content in a good way.

3. Write the overall quality of the program

Very nice

4. Will you recommend this program to your friends/juniors/seniors?

Yes, I recommend

Suggestions to improve, if any:

Nil

Signature of the Student

Bhavanaa . C

PERI INSTITUTE OF TECHNOLOGY
DEPARTMENT OF ELECTRONICS AND COMMUNICATION ENGINEERING
FEEDBACK FORM
ACADEMIC YEAR 2018-2019

Name of the Student: VIJAYA SUNDARAM.A.G.

Register No: 411516106065

Year: II

Date of Feedback: 13/07/2018.

Course Name: EMBEDDED BUILDING blocks USING ARDUINO

1. How do you value the course content?

Very useful

2. How would you understand the content delivery by the instructor?

Very understandable.

3. Write the overall quality of the program

Good

4. Will you recommend this program to your friends/juniors/seniors?

Yes

Suggestions to improve, if any:

Nothing

Signature of the Student

Vijaya Sundaram.A.G.

PERI

INSTITUTE OF TECHNOLOGY

DEPARTMENT OF ELECTRONICS AND COMMUNICATION ENGINEERING

Organizes

ADD ON COURSE IN

“EMBEDDED BUILDING BLOCKS USING ARUDINO HANDS ON FOR YOUNG”

CERTIFICATE

OF PARTICIPATION

This is to certify that Mr / Ms. D. ABINESH

of IV Year, Electronics and Communication Engineering, PERI Institute of Technology

has completed an add on course in **EMBEDDED BUILDING BLOCKS USING ARUDINO**

HANDS ON FOR YOUNG held from 07.07.18 to 13.07.18.



PRINCIPAL

COURSE COORDINATOR

PERI

INSTITUTE OF TECHNOLOGY

DEPARTMENT OF ELECTRONICS AND COMMUNICATION ENGINEERING

Organizes

ADD ON COURSE IN

“EMBEDDED BUILDING BLOCKS USING ARUDINO HANDS ON FOR YOUNG”

CERTIFICATE
OF PARTICIPATION

This is to certify that Mr / Ms. C. BHUVANAA

of III Year, Electronics and Communication Engineering, PERI Institute of Technology

has completed an add on course in **EMBEDDED BUILDING BLOCKS USING ARUDINO**

HANDS ON FOR YOUNG held from 07.07.18 to 13.07.18.



PRINCIPAL

COURSE COORDINATOR

PERI

INSTITUTE OF TECHNOLOGY

DEPARTMENT OF ELECTRONICS AND COMMUNICATION ENGINEERING

Organizes

ADD ON COURSE IN

"EMBEDDED BUILDING BLOCKS USING ARUDINO HANDS ON FOR YOUNG"

CERTIFICATE
OF PARTICIPATION

This is to certify that Mr / Ms. B. KISHORE

of IV Year, Electronics and Communication Engineering, PERI Institute of Technology

has completed an add on course in **EMBEDDED BUILDING BLOCKS USING ARUDINO**

HANDS ON FOR YOUNG held from 07.07.18 to 13.07.18.



PRINCIPAL

COURSE COORDINATOR

PERI INSTITUTE OF TECHNOLOGY
Mannivakkam, Chennai 600048
DEPARTMENT OF ELECTRICAL AND ELECTRONICS ENGINEERING
ACADEMIC YEAR 2018 - 2019

Ref: PERIIT/EEE/CC /2018-19/003

Date: 27.06.2018

CIRCULAR

The Electrical and Electronics Engineering Department of PERI IT has planned to conduct Add-on course titled "Python Programming for Power Electronics" for II, III and IV year EEE students.

S.No.	Year	Scheduled Date	Session 1	Session 2
1	II/III/IV	11-07-2018 to 15-07-2018	8.30 AM to 11.45AM	12.30 PM to 03.30 PM

Coordinator

HoD/EEE

Copy To:

1. Principal
2. Vice – Principal
3. IQAC
4. Faculty Members
5. Notice Board

PERI INSTITUTE OF TECHNOLOGY

Mannivakkam, Chennai 600048

DEPARTMENT OF ELECTRICAL AND ELECTRONICS ENGINEERING

ACADEMIC YEAR 2018-2019

Minutes of Meeting

Course Code: EA008

Course Name: Python Programming for Power Electronics

Venue: HOD Room, Beta Block, PERI IT

Date: 02/07/2018 Time: 12.00 PM - 1.00 PM

Agenda of the meeting:

1. Syllabus preparation
2. Tentative Time Table
3. Assessment method

Members present:

1. Dr. Kc. Jayasankar, HOD/EEE,
2. Ms. S. L. Sreedevi, Co Ordinator,
3. Mr. R. Tamilamuthan,
4. Mr. D. Sathyaraj,

Ms. S. L. Sreedevi, Co Ordinator welcomed and briefed the committee members about the agenda.

Agenda Item 1: Syllabus preparation

The syllabus is framed accordingly in order to meet the objectives of the course, various Universities, IITs, NITs syllabus has been taken into consideration for syllabus preparation.

Agenda Item 2: Tentative Time Table

The timetable is prepared as per the university requirement and communicated to the subject expert.

Agenda Item 3: Assessment method

Two assessment will be conducted at the end of the course.

Coordinator

Senior Faculty Member

HOD/EEE

PRINCIPAL

Dr. R. PALSON KENNEDY, M.E., Ph.D.
PRINCIPAL
PERI INSTITUTE OF TECHNOLOGY
Mannivakkam, Chennai - 600 048

PERI INSTITUTE OF TECHNOLOGY

Mannivakkam, Chennai 600048

DEPARTMENT OF ELECTRICAL AND ELECTRONICS ENGINEERING

ACADEMIC YEAR 2018-2019

SHORT DESCRIPTION

Course Code : EA008

Course Name: Python Programming for Power Electronics

Python Programming for Power Electronics course provides a comprehensive introduction to using Python programming language for power electronics applications. This will help to learn the fundamentals of Python programming, including syntax, data structures, and control flow, and explore how to apply these concepts to solve problems specific to power electronics engineering. Through hands-on exercises, students will gain proficiency in utilizing Python libraries such as NumPy, SciPy, and Pandas for scientific computing, data analysis, and visualization.

COURSE OBJECTIVES

- To understand the core concepts of Python programming language, including variables, data types, control structures, functions, and modules
- To learn and utilize Python libraries such as NumPy, SciPy, and Pandas for numerical computing, scientific analysis, and data manipulation tasks relevant to power electronics
- To develop the ability to simulate power electronics circuits and analyze their behavior using Python, integrating with simulation tools like SPICE for comprehensive design and analysis
- To gain proficiency in developing and implementing control algorithms in Python to regulate and optimize the performance of power electronic systems, including closed-loop control strategies
- To explore various optimization techniques and apply them to power electronics design challenges, enhancing system efficiency, performance, and robustness

Coordinator

HOD/EEE

PERI INSTITUTE OF TECHNOLOGY

Mannivakkam, Chennai 600048

DEPARTMENT OF ELECTRICAL AND ELECTRONICS ENGINEERING

ACADEMIC YEAR 2018-2019

SYLLABUS

MODULE 1: INTRODUCTION TO PYTHON FOR POWER ELECTRONICS

Overview of Python programming language, Setting up the Python development environment, Python basics: variables, data types, operators, and expressions

MODULE 2: NUMERICAL COMPUTING WITH NUMPY

Introduction to NumPy for numerical computing, Working with arrays and matrices, NumPy functions for mathematical operations

MODULE 3: DATA MANIPULATION WITH PANDAS

Introduction to Pandas for data manipulation, Handling data structures: Series and Data Frames, Data cleaning, filtering, and manipulation with Pandas

MODULE 4: SIMULATING POWER ELECTRONICS CIRCUITS WITH PYTHON

Overview of power electronics concepts, Integrating Python with SPICE for circuit simulation, Simulating basic power electronic circuits

MODULE 5: CONTROL SYSTEMS AND OPTIMIZATION

Basics of control systems in power electronics, Implementing control algorithms in Python, Introduction to optimization techniques and their application to power electronics design



Coordinator



HOD/EEE

PERI INSTITUTE OF TECHNOLOGY
DEPARTMENT OF ELECTRICAL AND ELECTRONICS ENGINEERING

ACADEMIC YEAR 2018-2019

TIME TABLE

Course Code : EA008

Course Name: Python Programming for Power Electronics

S.No	DATE	HOURS	TOPIC
1	11.07.2018	1st-6th	Overview of Python programming language, Setting up the Python development environment, Python basics: variables, data types, operators, and expressions
2	12.07.2018	1st-6th	Introduction to NumPy for numerical computing, Working with arrays and matrices, NumPy functions for mathematical operations
3	13.07.2018	1st-6th	Introduction to Pandas for data manipulation, Handling data structures: Series and Data Frames, Data cleaning, filtering, and manipulation with Pandas
4	14.07.2018	1st-6th	Overview of power electronics concepts, Integrating Python with SPICE for circuit simulation, Simulating basic power electronic circuits
5	15.07.2018	1st-6th	Basics of control systems in power electronics, Implementing control algorithms in Python, Introduction to optimization techniques and their application to power electronics design

Coordinator

HOD/EEE

PERI INSTITUTE OF TECHNOLOGY
DEPARTMENT OF ELECTRICAL AND ELECTRONICS ENGINEERING
ACADEMIC YEAR 2018-2019

II - EEE

S. No	Register Number	Student Name
1.	411517105002	Annem Chaitanya Kumar Reddy
2.	411517105003	Aravind G
3.	411517105004	Arivarasi A
4.	411517105005	Arun N
5.	411517105006	Chandru S J
6.	411517105007	Deepakkumar J
7.	411517105008	Dinesh Kumar B
8.	411517105009	Donald Santhuru S
9.	411517105010	Eshwar M
10.	411517105011	Giridharan K
11.	411517105012	Goli Sai Supriya
12.	411517105013	Ilavaruna Karthik P
13.	411517105014	Jayasri A
14.	411517105015	Jeevitha S
15.	411517105016	Karan Raj S
16.	411517105017	Keerthivasan C
17.	411517105018	Manoj M
18.	411517105019	Mohamed Rizwan R
19.	411517105020	Monisha M
20.	411517105021	Mukesh S
21.	411517105022	Naveen Kumar M
22.	411517105023	Poomani R
23.	411517105024	Rahman H
24.	411517105025	Rajesh S
25.	411517105026	Rishika P
26.	411517105028	Rukmani V
27.	411517105029	Santhosh Kumar S
28.	411517105030	Sham Prabu A
29.	411517105031	Sharon Devakirubai B
30.	411517105032	Sugan C
31.	411517105033	Swetha R
32.	411517105034	Swetha S
33.	411517105036	Vani D
34.	411517105037	Vigneshwaran R
35.	411517105301	Jagan
36.	411517105302	Premraj
37.	411517105303	Vivek
38.	411517105304	Yeshwanth

PERI INSTITUTE OF TECHNOLOGY
DEPARTMENT OF ELECTRICAL AND ELECTRONICS ENGINEERING
ACADEMIC YEAR 2018-2019

III - EEE

S. No	Register Number	Student Name
1.	411516105001	Aarthy S
2.	411516105002	Balasubramani V
3.	411516105003	Caleb W
4.	411516105004	Dhevadharshini V
5.	411516105005	Durai Murugan A
6.	411516105006	Guru Prasad R
7.	411516105007	Harikesh B
8.	411516105008	Harish
9.	411516105011	Sam C
10.	411516105012	Sameeran B
11.	411516105013	Vasanth V
12.	411516105014	Vishali R
13.	411516105301	Jagadesh N
14.	411516105302	Mahadeshwar S
15.	411516105303	Srinivasalu G K

Dr. R. PALSON KENNEDY, M.E., Ph.D.,
PRINCIPAL
PERI INSTITUTE OF TECHNOLOGY
Mannivakkam, Chennai - 600 048.

PERI INSTITUTE OF TECHNOLOGY
DEPARTMENT OF ELECTRICAL AND ELECTRONICS ENGINEERING
ACADEMIC YEAR 2018-2019

IV – EEE

S. No	Register Number	Student Name
1.	411515105001	Ajith Kumar P
2.	411515105002	Akesh M
3.	411515105003	Anish Kumar G
4.	411515105004	Arumatias K S
5.	411515105005	Balasubramanian N
6.	411515105006	Daniel Jones I S
7.	411515105007	Danush Adhithya N
8.	411515105008	Dinesh B
9.	411515105009	Dinesh T
10.	411515105010	Dinesh P
11.	411515105011	Dinesh Kumar M
12.	411515105012	Elaynchezhiyan K
13.	411515105013	Harish Kumar S
14.	411515105014	Harish Raj S
15.	411515105015	Kamali G L
16.	411515105016	Keerthana S
17.	411515105017	Kishore Babu C
18.	411515105018	Lesslee New Behan A
19.	411515105019	Malarvizhi S
20.	411515105020	Manikandan R
21.	411515105021	Manisha M
22.	411515105022	Mercy Petricia M
23.	411515105023	Nandakumar R
24.	411515105024	Naresh N
25.	411515105025	Naresh Kumar V N
26.	411515105026	Nirocine G
27.	411515105027	Pradeep Kumar K
28.	411515105028	Ragavan R
29.	411515105029	Rajalingam K
30.	411515105030	Rakesh R
31.	411515105031	Rishwan M
32.	411515105032	Shankar Narayanan V
33.	411515105033	Sowmiya S
34.	411515105034	Thanujaa S
35.	411515105035	Vijay G
36.	411515105036	Vijay N
37.	411515105037	Vinothini G
38.	411515105038	Vishnu Priya B
39.	411515105039	Viswesh K
40.	411515105040	Yogeetha S

PERI INSTITUTE OF TECHNOLOGY
DEPARTMENT OF ELECTRICAL AND ELECTRONICS ENGINEERING
ACADEMIC YEAR 2018-2019

Attendance

Course Code: EA008

Course Name: Python Programming for Power Electronics

S. No	Register Number	Name of the Student	Date				
			11-07-2018	12-07-2018	13-07-2018	14-07-2018	15-07-2018
II - EEE							
1.	411517105002	Annem Chaitanya Kumar Reddy	Chaitanya	Chaitanya	Chaitanya	Chaitanya	Chaitanya
2.	411517105003	Aravind G	Aravind G	Aravind G	Aravind G	Aravind G	Aravind G
3.	411517105004	Arivarasi A	Arivarasi A	Arivarasi A	Arivarasi A	Arivarasi A	Arivarasi A
4.	411517105005	Arun N	Arun N	Arun N	Arun N	Arun N	Arun N
5.	411517105006	Chandru S J	Chandru S J	Chandru S J	Chandru S J	Chandru S J	Chandru S J
6.	411517105007	Deepakkumar J	Deepakkumar J	Deepakkumar J	Deepakkumar J	Deepakkumar J	Deepakkumar J
7.	411517105008	Dinesh Kumar B	Dinesh Kumar B	Dinesh Kumar B	Dinesh Kumar B	Dinesh Kumar B	Dinesh Kumar B
8.	411517105009	Donald Santhuru S	Santhuru S	Santhuru S	Santhuru S	Santhuru S	Santhuru S
9.	411517105010	Eshwar M	Eshwar M	Eshwar M	Eshwar M	Eshwar M	Eshwar M
10.	411517105011	Giridharan K	Giridharan K	Giridharan K	Giridharan K	Giridharan K	Giridharan K
11.	411517105012	Goli Sai Supriya	Sai Supriya	Sai Supriya	Sai Supriya	Sai Supriya	Sai Supriya
12.	411517105013	Ilavaruna Karthik P	Karthik P	Karthik P	Karthik P	Karthik P	Karthik P

13.	411517105014	Jayasri A	Jayasri A	Jayasri A	Jayasri A	Jayasri A	Jayasri A
14.	411517105015	Jeevitha S	Jeevitha S	Jeevitha S	Jeevitha S	Jeevitha S	Jeevitha S
15.	411517105016	Karan Raj S	Karan Raj S	Karan Raj S	Karan Raj S	Karan Raj S	Karan Raj S
16.	411517105017	Keerthivasan C	Keerthivasan C	Keerthivasan C	Keerthivasan C	Keerthivasan C	Keerthivasan C
17.	411517105018	Manoj M	Manoj M	Manoj M	Manoj M	Manoj M	Manoj M
18.	411517105019	Mohamed Rizwan R	Mohamed Rizwan R	Mohamed Rizwan R	Mohamed Rizwan R	Mohamed Rizwan R	Mohamed Rizwan R
19.	411517105020	Monisha M	Monisha M	Monisha M	Monisha M	Monisha M	Monisha M
20.	411517105021	Mukesh S	Mukesh S	Mukesh S	Mukesh S	Mukesh S	Mukesh S
21.	411517105022	Naveen Kumar M	Naveen Kumar M	Naveen Kumar M	Naveen Kumar M	Naveen Kumar M	Naveen Kumar M
22.	411517105023	Poomani R	Poomani R	Poomani R	Poomani R	Poomani R	Poomani R
23.	411517105024	Rahman H	Rahman H	Rahman H	Rahman H	Rahman H	Rahman H
24.	411517105025	Rajesh S	Rajesh S	Rajesh S	Rajesh S	Rajesh S	Rajesh S
25.	411517105026	Rishika P	Rishika P	Rishika P	Rishika P	Rishika P	Rishika P
26.	411517105028	Rukmani V	Rukmani V	Rukmani V	Rukmani V	Rukmani V	Rukmani V
27.	411517105029	Santhosh Kumar S	Santhosh Kumar S	Santhosh Kumar S	Santhosh Kumar S	Santhosh Kumar S	Santhosh Kumar S
28.	411517105030	Sham Prabu A	Sham Prabu A	Sham Prabu A	Sham Prabu A	Sham Prabu A	Sham Prabu A
29.	411517105031	Sharon Devakirubai B	Sharon Devakirubai B	Sharon Devakirubai B	Sharon Devakirubai B	Sharon Devakirubai B	Sharon Devakirubai B
30.	411517105032	Sugan C	Sugan C	Sugan C	Sugan C	Sugan C	Sugan C
31.	411517105033	Swetha R	Swetha R	Swetha R	Swetha R	Swetha R	Swetha R
32.	411517105034	Swetha S	Swetha S	Swetha S	Swetha S	Swetha S	Swetha S
33.	411517105036	Vani D	Vani D	Vani D	Vani D	Vani D	Vani D
34.	411517105037	Vigneshwaran R	Vigneshwaran R	Vigneshwaran R	Vigneshwaran R	Vigneshwaran R	Vigneshwaran R
35.	411517105301	Jagan	Jagan	Jagan	Jagan	Jagan	Jagan
36.	411517105302	Premraj	Premraj	Premraj	Premraj	Premraj	Premraj
37.	411517105303	Vivek	Vivek	Vivek	Vivek	Vivek	Vivek
38.	411517105304	Yeshwanth	Yeshwanth	Yeshwanth	Yeshwanth	Yeshwanth	Yeshwanth
III - EEE							
1.	411516105001	Aarthy S	Aarthy S	Aarthy S	Aarthy S	Aarthy S	Aarthy S
2.	411516105002	Balasubramani V	Balasubramani V	Balasubramani V	Balasubramani V	Balasubramani V	Balasubramani V
3.	411516105003	Caleb W	Caleb W	Caleb W	Caleb W	Caleb W	Caleb W
4.	411516105004	Dhevadharshini V	Dhevadharshini V	Dhevadharshini V	Dhevadharshini V	Dhevadharshini V	Dhevadharshini V

5.	411516105005	Durai Murugan A	Murugan A	Murugan A	Murugan A	Murugan A	Murugan A
6.	411516105006	Guru Prasad R	Guru Prasad R	Guru Prasad R	Guru Prasad R	Guru Prasad R	Guru Prasad R
7.	411516105007	Harikesh B	Harikesh B	Harikesh B	Harikesh B	Harikesh B	Harikesh B
8.	411516105008	Harish	Harish	Harish	Harish	Harish	Harish
9.	411516105011	Sam C	SAM.C	SAM.C	SAM.C	SAM.C	SAM.C
10.	411516105012	Sameeran B	Sameeran B	Sameeran B	Sameeran B	Sameeran B	Sameeran B
11.	411516105013	Vasanth V	Vasanth V	Vasanth V	Vasanth V	Vasanth V	Vasanth V
12.	411516105014	Vishali R	Vishali R	Vishali R	Vishali R	Vishali R	Vishali R
13.	411516105301	Jagadesh N	Jagadesh N	Jagadesh N	Jagadesh N	Jagadesh N	Jagadesh N
14.	411516105302	Mahadeshwar S	Mahadeshwar S	Mahadeshwar S	Mahadeshwar S	Mahadeshwar S	Mahadeshwar S
15.	411516105303	Srinivasalu G K	Srinivasalu G K	Srinivasalu G K	Srinivasalu G K	Srinivasalu G K	Srinivasalu G K

IV - EEE

1.	411515105001	Ajith Kumar P	Ajith Kumar P	Ajith Kumar P	Ajith Kumar P	Ajith Kumar P	Ajith Kumar P
2.	411515105002	Akesh M	Akesh M	Akesh M	Akesh M	Akesh M	Akesh M
3.	411515105003	Anish Kumar G	Anish Kumar G	Anish Kumar G	Anish Kumar G	Anish Kumar G	Anish Kumar G
4.	411515105004	Arumathias K S	Arumathias K S	Arumathias K S	Arumathias K S	Arumathias K S	Arumathias K S
5.	411515105005	Balasubramanian N	Balasubramanian N	Balasubramanian N	Balasubramanian N	Balasubramanian N	Balasubramanian N
6.	411515105006	Daniel Jones I S	Daniel Jones I S	Daniel Jones I S	Daniel Jones I S	Daniel Jones I S	Daniel Jones I S
7.	411515105007	Danush Adhithya N	Danush Adhithya N	Danush Adhithya N	Danush Adhithya N	Danush Adhithya N	Danush Adhithya N
8.	411515105008	Dinesh B	Dinesh B	Dinesh B	Dinesh B	Dinesh B	Dinesh B
9.	411515105009	Dinesh T	Dinesh T	Dinesh T	Dinesh T	Dinesh T	Dinesh T
10.	411515105010	Dinesh P	Dinesh P	Dinesh P	Dinesh P	Dinesh P	Dinesh P
11.	411515105011	Dinesh Kumar M	Dinesh Kumar M	Dinesh Kumar M	Dinesh Kumar M	Dinesh Kumar M	Dinesh Kumar M
12.	411515105012	Elaynchezhiyan K	Elaynchezhiyan K	Elaynchezhiyan K	Elaynchezhiyan K	Elaynchezhiyan K	Elaynchezhiyan K
13.	411515105013	Harish Kumar S	Harish Kumar S	Harish Kumar S	Harish Kumar S	Harish Kumar S	Harish Kumar S
14.	411515105014	Harish Raj S	Harish Raj S	Harish Raj S	Harish Raj S	Harish Raj S	Harish Raj S
15.	411515105015	Kamali G L	Kamali G L	Kamali G L	Kamali G L	Kamali G L	Kamali G L
16.	411515105016	Keerthana S	Keerthana S	Keerthana S	Keerthana S	Keerthana S	Keerthana S
17.	411515105017	Kishore Babu C	Kishore Babu C	Kishore Babu C	Kishore Babu C	Kishore Babu C	Kishore Babu C
18.	411515105018	Lesslee New Behan A	Lesslee New Behan A	Lesslee New Behan A	Lesslee New Behan A	Lesslee New Behan A	Lesslee New Behan A
19.	411515105019	Malarvizhi S	Malarvizhi S	Malarvizhi S	Malarvizhi S	Malarvizhi S	Malarvizhi S

20.	411515105020	Manikandan R	R. Manikandan	R. Manikandan	R. Manikandan	R. Manikandan	R. Manikandan
21.	411515105021	Manisha M	M	M	M	M	M
22.	411515105022	Mercy Petricia M	Mercy Petricia	Mercy Petricia	Mercy Petricia	Mercy Petricia	Mercy Petricia
23.	411515105023	Nandakumar R	Nandakumar	Nandakumar	Nandakumar	Nandakumar	Nandakumar
24.	411515105024	Naresh N	N	N	N	N	N
25.	411515105025	Naresh Kumar V N	Naresh Kumar	Naresh Kumar	Naresh Kumar	Naresh Kumar	Naresh Kumar
26.	411515105026	Nirocine G	Nirocine	Nirocine	Nirocine	Nirocine	Nirocine
27.	411515105027	Pradeep Kumar K	Pradeep	Pradeep	Pradeep	Pradeep	Pradeep
28.	411515105028	Ragavan R	Ragavan	Ragavan	Ragavan	Ragavan	Ragavan
29.	411515105029	Rajalingam K	Rajalingam	Rajalingam	Rajalingam	Rajalingam	Rajalingam
30.	411515105030	Rakesh R	Rakesh	Rakesh	Rakesh	Rakesh	Rakesh
31.	411515105031	Rishwan M	M. Rishwan	M. Rishwan	M. Rishwan	M. Rishwan	M. Rishwan
32.	411515105032	Shankar Narayanan V	Shankar	Shankar	Shankar	Shankar	Shankar
33.	411515105033	Sowmiya S	Sowmiya	Sowmiya	Sowmiya	Sowmiya	Sowmiya
34.	411515105034	Thanujaa S	Thanujaa	Thanujaa	Thanujaa	Thanujaa	Thanujaa
35.	411515105035	Vijay G	Vijay	Vijay	Vijay	Vijay	Vijay
36.	411515105036	Vijay N	Vijay	Vijay	Vijay	Vijay	Vijay
37.	411515105037	Vinothini G	Vinothini	Vinothini	Vinothini	Vinothini	Vinothini
38.	411515105038	Vishnu Priya B	Vishnu Priya	Vishnu Priya	Vishnu Priya	Vishnu Priya	Vishnu Priya
39.	411515105039	Viswesh K	Viswesh	Viswesh	Viswesh	Viswesh	Viswesh
40.	411515105040	Yogeetha S	Yogeetha	Yogeetha	Yogeetha	Yogeetha	Yogeetha

Coordinator



Dr. R. PALSON KENNEDY, M.E., Ph.D.
PRINCIPAL
PERI INSTITUTE OF TECHNOLOGY
Mannivakkam, Chennai - 600 048

HOD/EEE

PERI INSTITUTE OF TECHNOLOGY
Mannivakkam, Chennai 600048
DEPARTMENT OF ELECTRICAL AND ELECTRONICS ENGINEERING
ACADEMIC YEAR 2018-2019

Assessment

Course Code : EA008

Course Name: Python Programming for Power Electronics

1. A thyristor (SCR) is a
 - a) N-P-N device
 - b) P-N-P-N device
 - c) P-N device
 - d) P-N-P device

2. The MOSFET combines the areas of _____ & _____
 - a) Semiconductor & TTL
 - b) MOS Technology & CMOS Technology
 - c) Field Effect & MOS Technology
 - d) None of the mentioned

3. The controlling parameter in MOSFET is
 - a) I_g
 - b) V_{gs}
 - c) I_s
 - d) V_{ds}

4. Fully controlled converter uses
 - a) Thyristors only
 - b) Both Diodes and Thyristors
 - c) Diodes only
 - d) None of the mentioned

5. What does Matplotlib provide in Python?
 - a) Data manipulation
 - b) Data visualization
 - c) Machine learning
 - d) Text processing

6. Which of the following functions is used to create a scatter plot in Matplotlib?
 - a) plot()
 - b) bar()
 - c) scatter()
 - d) line()

7. What is the purpose of the xlabel() function in Matplotlib?
 - a) Set the x-axis label
 - b) Set the y-axis label
 - c) Set the title of the plot
 - d) Set the legend

21
25

~~Code~~
15/7/18

8. Which Matplotlib method is used to save a figure to a file?

- a) savefig()
- b) saveplot()
- c) exportfig()
- d) downloadfig()

9. What is the purpose of the legend() function in Matplotlib?

- a) Display the plot title
- b) Display the axis labels
- c) Display a legend
- d) Display the grid

10. How do you set the title of a plot in Matplotlib?

- a) title() method
- b) set_title() method
- c) plot_title() method
- d) set_plot_title() method

11. Which of the following is a valid Matplotlib style?

- a) Classic
- b) Modern
- c) Trendy
- d) Fancy

12. How can you add text annotations to a Matplotlib plot?

- a) annotate() method
- b) add_text() method
- c) text() method
- d) add_annotation() method

13. Which Matplotlib method is used to set the figure size?

- a) set_size()
- b) figure_size()
- c) set_figure_size()
- d) figure(figsize=())

14. What is the purpose of the subplot() function in Matplotlib?

- a) Create multiple plots in one figure
- b) Set the subplot title
- c) Add subplots to a figure
- d) Adjust subplot spacing

15. How can you create a 3D plot in Matplotlib?

- a) plot_3d() method
- b) scatter_3d() method
- c) create_3d_plot() method
- d) plot() with projection='3d' parameter

16. How can you add a colorbar to a Matplotlib plot?

- a) add_colorbar() method
- b) create_colorbar() method
- c) colorbar() method
- d) set_colorbar() method

17. Which device can be used in a chopper circuit?

- a) MOSFET
- b) GTO
- c) BJT
- d) All of the mentioned

18. All keywords in Python are in _____

- a) Capitalized
- b) Lower case
- c) UPPER CASE
- d) None of the mentioned

19. What does pip stand for python?

- a) Pip Installs Packages
- b) Pip Installs Python
- c) Preferred Installer Program
- d) All of the mentioned

20. What arithmetic operators cannot be used with strings in Python?

- a) *
- b) -
- c) +
- d) All of the mentioned

21. To add a new element to a list we use which Python command?

- a) list1.addLast(5)
- b) list1.append(5)
- c) list1.add(5)
- d) list1.addEnd(5)

22. Which of the following is a Python tuple?

- a) {1, 2, 3}
- b) {}
- c) [1, 2, 3]
- d) (1, 2, 3)

23. What is the purpose of NumPy in Python?

- a) To do numerical calculations
- b) To do scientific computing
- c) Both A and B
- d) None of the mentioned above

24. What is the shape of a 1D NumPy array with 5 elements?

- a) (1, 5)
- b) (5,)
- c) (5, 1)
- d) (1,)

25. How can you access the element at the second row and third column of a 2D NumPy array arr?

- a) arr[1, 2]
- b) arr[2, 3]
- c) arr[1][2]
- d) arr[2][3]

PERI INSTITUTE OF TECHNOLOGY
DEPARTMENT OF ELECTRICAL AND ELECTRONICS ENGINEERING
FEEDBACK FORM
ACADEMIC YEAR 2018-2019

Name of the Student: Donald Santhuru S. Register No.: 411517105009
Year: II - EEE Date of Feedback: 15/07/2018
Course Name: Python Programming For Power Electronics

1. How do you value the course content?

The content was neat and fair

2. How would you understand the content delivery by the instructor?

The knowledge shared by the instructor was fair enough.

3. Write the overall quality of the program

The quality of the program was Extraordinary

4. Will you recommend this program to your friends/juniors/seniors?

Yes

Suggestions to improve, if any:

Santhuru S.
Signature of the Student

PERI INSTITUTE OF TECHNOLOGY
DEPARTMENT OF ELECTRICAL AND ELECTRONICS ENGINEERING
FEEDBACK FORM
ACADEMIC YEAR 2018-2019

Name of the Student: CALEB W

Register No.: 411516105003

Year: III - EEE

Date of Feedback: 15/07/2018

Course Name: PYTHON PROGRAMMING FOR POWER ELECTRONICS

1. How do you value the course content?

It's been very useful

2. How would you understand the content delivery by the instructor?

The Instructor language was very understandable

3. Write the overall quality of the program

overall quality of the program was too good

4. Will you recommend this program to your friends/juniors/seniors?

yes

Suggestions to improve, if any:

Nil

Caleb . W

Signature of the Student

PERI INSTITUTE OF TECHNOLOGY
DEPARTMENT OF ELECTRICAL AND ELECTRONICS ENGINEERING

FEEDBACK FORM

ACADEMIC YEAR 2018-2019

Name of the Student: MERCY PETAICIAM

Register No.: 211515105022

Year: IV - EEE

Date of Feedback: 15/07/2018

Course Name: PYTHON PROGRAMMING FOR
POWER ELECTRONICS

1. How do you value the course content?

The course content was admirable towards future.

2. How would you understand the content delivery by the instructor?

The instructor has a positive attitude which helps to understand better.

3. Write the overall quality of the program

Mind-blowing

4. Will you recommend this program to your friends/juniors/seniors?

Definitely I will recommend.

Suggestions to improve, if any: NIL

Mercy Petric
Signature of the Student

PERI

INSTITUTE OF TECHNOLOGY

DEPARTMENT OF ELECTRICAL AND ELECTRONICS ENGINEERING

Organizes

ADD ON COURSE IN

"PYTHON PROGRAMMING FOR POWER ELECTRONICS"

CERTIFICATE
OF PARTICIPATION

This is to certify that Mr / Ms. DONALD SANTHURU S

of II Year, Electrical and Electronics Engineering, PERI Institute of Technology has completed an add on course in **PYTHON PROGRAMMING FOR POWER ELECTRONICS** held from **11/07/2018** to **15/07/2018**.

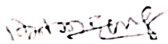

PRINCIPAL



VICE PRINCIPAL



HOD



COORDINATOR

www.peri.education

PERI Knowledge Park, Mannivakkam, Chennai - 600048

PERI

INSTITUTE OF TECHNOLOGY

DEPARTMENT OF ELECTRICAL AND ELECTRONICS ENGINEERING

Organizes

ADD ON COURSE IN

"PYTHON PROGRAMMING FOR POWER ELECTRONICS"

CERTIFICATE
OF PARTICIPATION

This is to certify that Mr /Ms. CALEB W

of III Year, Electrical and Electronics Engineering, PERI Institute of Technology has completed an add on course in **PYTHON PROGRAMMING FOR POWER ELECTRONICS** held from **11/07/2018** to **15/07/2018**.

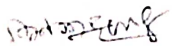

PRINCIPAL



VICE PRINCIPAL



HOD



COORDINATOR

www.peri.education

PERI Knowledge Park, Mannivakkam, Chennai - 600048

PERI

INSTITUTE OF TECHNOLOGY

DEPARTMENT OF ELECTRICAL AND ELECTRONICS ENGINEERING

Organizes

ADD ON COURSE IN

"PYTHON PROGRAMMING FOR POWER ELECTRONICS"

CERTIFICATE
OF PARTICIPATION

This is to certify that Mr / Ms. MERCY PETRICIA M

of IV Year, Electrical and Electronics Engineering, PERI Institute of Technology has completed an add on course in **PYTHON PROGRAMMING FOR POWER ELECTRONICS** held from **11/07/2018** to **15/07/2018**.

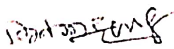

PRINCIPAL



VICE PRINCIPAL



HOD



COORDINATOR

www.peri.education

PERI Knowledge Park, Mannivakkam, Chennai - 600048

PERI INSTITUTE OF TECHNOLOGY
Mannivakkam, Chennai 600048
DEPARTMENT OF MECHANICAL ENGINEERING
ACADEMIC YEAR 2018-2019

Ref: PERIIT /MECH /Workshop/2018-19/01

Date: 06.12.2018

CIRCULAR

The Mechanical Engineering Department of PERI IT has planned to conduct workshop titled "CATIA" for the Academic year of 2018 – 2019 for II, III & IV year Mechanical students.

Sl. No.	Year	Scheduled Date	Session 1	Session 2
1	II, III & IV	22.03.2019 – 04.05.2019	8.30 AM to 11.45AM	12.30PM to 3.30PM

Co-Ordinator

Head of the Department

Head of the Department
Dept. of Mechanical Engg.
PERI INSTITUTE OF TECH.
Mannivakkam, Ch-600 048.

Copy To:

1. Principal
2. Vice – Principal
3. IQAC
4. Faculty Members
5. Notice Board

PERI INSTITUTE OF TECHNOLOGY

Mannivakkam, Chennai 600048

DEPARTMENT OF MECHANICAL ENGINEERING

ACADEMIC YEAR 2018-2019

Minutes of the Meeting

Course code and Name: MEW005 CATIA

Venue: HOD Room, Beta Block, PERI IT

Date: 22/12/2019 Time: 12.00-1.00PM

Agenda of the meeting:

1. Syllabus preparation
2. Tentative Time Table
3. Assessment method

Members present:

1. Mr. Anil Kumar, HOD/Mech
2. Dr. R. M. Sathyamoorthy, Assistant Professor / Mech
3. Mr. Sundarapandiyan, Assistant Professor / Mech
4. Mr. Dhilip Kumar, Assistant Professor / Mech

Mr. Sundarapandiyan, Coordinator welcomed and briefed the committee members about the agenda.

Agenda Item 1: Syllabus preparation for Solid works

The syllabus is framed accordingly in order to meet the objectives of the course, various Universities, IITs, NITs syllabus has been taken into consideration for syllabus preparation.

Agenda Item 2: Tentative Time Table

The timetable is prepared as per the university requirement and communicated to the subject expert.

Agenda Item 3: Assessment method

Assessment exam will be conducted at the end of the course.

Coordinator
22/12/19

Senior faculty member

HOD MECH

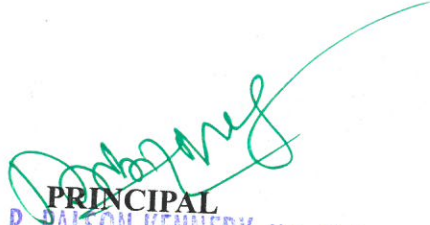
PRINCIPAL
Dr. R. PALSON KENNEDY, M.E., Ph.D.
PRINCIPAL
PERI INSTITUTE OF TECHNOLOGY
Mannivakkam, Ch-600048
PERI INSTITUTE OF TECHNOLOGY
Mannivakkam, Chennai - 600048

PERI INSTITUTE OF TECHNOLOGY

Mannivakkam, Chennai 600048

DEPARTMENT OF MECHANICAL ENGINEERING

SHORT DESCRIPTION

Course Code: MEW005

Course Name: CATIA

CATIA is the reduced form of Computer Aided Three-Dimensional Interactive Application developed by French company Dassault Systems and marketed worldwide by IBM. It is a complete multi-platform solution for Computer-Aided Design (CAD), Computer-Aided Manufacturing (CAM), Computer-Aided Engineering (CAE), PLM and 3D.

CATIA is product design software, which is ideal for surfaces, creating solids, drawings, assemblies, fabrication and analysis. This software is used in multiple industries like in manufacturing industries, automobile, aerospace, etc. to visualize designs in 3D. These industries use CATIA to model any product, to integrate 3D features with 2D tools and to develop 2D drawing views

COURSE OBJECTIVES

Create three-dimensional assemblies incorporating multiple solid models. Apply industry standards in the preparation of technical mechanical drawings.

- Use their capacity of vision to interpret and/or convey the technical information in an industrial drawing.
- Know and be able to apply graphical representation techniques using traditional metric geometry and descriptive geometry methods.
- Know, identify, interpret and apply the current standards on Industrial Technical Drawing.
- Computer aided design applications that allow students to elaborate and use graphical and technical information.

Coordinator

HOD/MECH

Head of the Department
Dept. of Mechanical Engg.
PERI INSTITUTE OF TECH.
Mannivakkam, Ch-600 048.

PERI INSTITUTE OF TECHNOLOGY

Mannivakkam, Chennai 600048

DEPARTMENT OF MECHANICAL ENGINEERING

MEW005 – CATIA

Syllabus

Session 1: Introduction to CATIA

CATIA as a CAD software: - Concept of Parametric Modeling, Feature Based Modeling, User Interface, Mouse operations, File types and Management, drawing profiles. Major user industries of CATIA.

Session 2: Sketch

Profile toolbar, operation (corner, chamfer, relimitations, transformations, project 3D element), constraints, types of constraints, workbench. sketch tools, tools(Sketch solving status, sketch analysis, output feature), visualization toolbar, user selection filter.

Session 3: Modeling of Machined component

Material Addition and Removal (Pad, Pocket, Shaft, Groove), Sketch and Positioned Sketch, Types of Fillets, Types of Chamfer, Types of Hole.

Session 4: Advance Design features

Axis System, Types of draft, Shell, Stiffener, rib slot, Multisection solid, Removed multisection solid, Apply Material, Measure, Render

Session 5: Solid 3D Modeling.

Obtaining 2D drawings. Assembly of mechanical assemblies. CAD practice. CATIA V5 sketcher, Part, Generative Drafting, product and assembly modules.

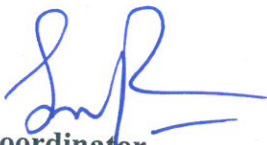
Coordinator

HOD/MECH

Head of the Department
Dept. of Mechanical Engg.
PERI INSTITUTE OF TECH.
Mannivakkam, Ch-600 048,

PERI INSTITUTE OF TECHNOLOGY
DEPARTMENT OF MECHANICAL ENGINEERING

TIME TABLE

Course Code: MEW005

Year/Semester: II,III,IV / IV,VI,VIII

Course Name: CATIA

Session: FN & AN

Sl. No	DATE	HOURS	TOPICS
1	22.03.2019	1-6 th hour	CATIA as a CAD software: - Concept of Parametric Modeling, Feature Based Modeling, User Interface, Mouse operations, File types and Management, drawing profiles. Major user industries of CATIA.
2	30.03.2019	1-6 th hour	Profile toolbar, operation (corner, chamfer, relimitations, transformations, project 3D element), constraints, types of constraints, workbench. sketch tools, tools(Sketch solving status, sketch analysis, output feature), visualization toolbar, user selection filter.
3	20.04.2019	1-6 th hour	Material Addition and Removal (Pad, Pocket, Shaft, Groove), Sketch and Positioned Sketch, Types of Fillets, Types of Chamfer, Types of Hole.
4	27.04.2019	1-6 th hour	Axis System, Types of draft, Shell, Stiffener, rib slot, Multisection solid, Removed multisection solid, Apply Material, Measure, Render
5	04.05.2019	1-6 th hour	Obtaining 2D drawings. Assembly of mechanical assemblies. CAD practice. CATIA V5 sketcher, Part, Generative Drafting, product and assembly modules.

Coordinator

HOD/MESH

Head of the Department
 Dept. of Mechanical Engg.
 PERI INSTITUTE OF TECH.
 Mannivakkam, Ch-600 048.

PERI INSTITUTE OF TECHNOLOGY
Mannivakkam, Chennai 600048
DEPARTMENT OF MECHANICAL ENGINEERING
ACADEMIC YEAR 2018-2019

Participants Name List
Course Name – CATIA

Course Code: MEW005

Year/Semester: II / IV

Sl. No	Registration Number	Student Name
51	411517114064	JAIADITHIYAN P
52	411517114067	KAMALESH E
53	411517114068	KARAN SINGH J
54	411517114070	KARTHICKKUMAR S
55	411517114071	KARTHIKEYAN R
56	411517114072	KARUPPASAMY A
57	411517114073	KAVIARASAN J
58	411517114075	LOGESHWARAN S
59	411517114076	LOKESH S
60	411517114077	MADAN JASWANT RAHUL S
61	411517114078	MADHAVAN M
62	411517114079	MANICKAVASAGAR S
63	411517114080	MANIKANDAN C
64	411517114083	MANISH KUMAR R
65	411517114084	MANOJ G
66	411517114085	MANOJ KUMAR A
67	411517114086	MANYAM R CHARAN
68	411517114087	MARTIN ROY S
69	411517114088	MESHACH NEERAJ P V
70	411517114089	MITHUNA SRINIKA A
71	411517114091	MOHAMMED ABUL FATHAH Z
72	411517114092	MOOVENDHAN V
73	411517114093	MOSES JEBARAJ A
74	411517114094	MUGESH KANNAN M
75	411517114095	MUHAMMAD YASAR ARAFATH S

Sl. No	Registration Number	Student Name
76	411517114096	MUKESHKUMAR S
77	411517114097	MUTHURAMALINGAM V
78	411517114098	MUZAFAR AHAMED F
79	411517114099	NAKKEERAN N
80	411517114100	NATARAJAN G
81	411517114101	NEHRU T
82	411517114102	NITHISH KUMAR S
83	411517114103	PALANI S
84	411517114104	PALANIVEL RAJA K
85	411517114105	PALLAVARAJ V
86	411517114106	PARVENDHAN T
87	411517114107	PATURU VISHAL
88	411517114108	PAVITHRAN S
89	411517114110	PRABAKARAN J
90	411517114111	PRADEEP KUMAR K
91	411517114112	PRAVEEN KUMAR J
92	411517114113	PRAVEEN KUMAR M
93	411517114114	PRAVEEN KUMAR S (03- 03-1999)
94	411517114115	PRAVEEN KUMAR S (08- 04-2000)
95	411517114116	PRAVINKUMAR K
96	411517114117	PREM KUMAR J
97	411517114118	PRIYESH P
98	411517114119	RAGHU D
99	411517114120	RAGUL R
100	411517114122	RAMANAIAH C V

PERI INSTITUTE OF TECHNOLOGY
Mannivakkam, Chennai 600048
DEPARTMENT OF MECHANICAL ENGINEERING
ACADEMIC YEAR 2018-2019

Participants Name List
Course Name – CATIA

Course Code: MEW005

Year/Semester: II / IV

Sl. No	Registration Number	Student Name
101	411517114124	RAVIKUMARAN K
102	411517114125	REVANTH S
103	411517114126	RISIKESH K
104	411517114127	SABARI A
105	411517114128	SABBE SATHVIK
106	411517114129	SAI BHARGAV K
107	411517114130	SAKTHIANAND R
108	411517114131	SAKTHIVEL E
109	411517114132	SANDHIYA T
110	411517114134	SATHISH J
111	411517114135	SATHISHKUMAR S
112	411517114136	SELVADURAI C
113	411517114137	SELVAM P
114	411517114138	SENTHAMILAN K
115	411517114140	SOBIKA S
116	411517114142	SONU PRASAAD H
117	411517114143	SREEVATHSAN B
118	411517114144	SRIDHAR S
119	411517114145	SUDHEER V
120	411517114146	SUGUMARAN K
121	411517114147	SULTHAN BASHA A
122	411517114148	SURESH KUMAR S
123	411517114149	SURIYA K
124	411517114150	SYED NAZEEF
125	411517114151	THENNARASU R

Sl. No	Registration Number	Student Name
126	411517114152	THIYAGU C
127	411517114154	THULACI RAMAN R
128	411517114155	UDATHA MYTHRESH SAI MAHADEV
129	411517114156	VASANTHA KUMAR S
130	411517114157	VIGNESH A
131	411517114158	VIGNESH G (21-12-1999)
132	411517114159	VIGNESH G (23-12-1999)
133	411517114160	VIGNESH P
134	411517114161	VIGNESH R
135	411517114162	VIGNESHWARAN K
136	411517114164	VIKRAM P
137	411517114165	VIKRAMAN T
138	411517114168	YASAR ARUN S
139	411517114169	YUVAPRASATH B
140	411517114170	YVESRON P
141	411517114301	ARUN KUMAR G
142	411517114302	GANGADHARAN K
143	411517114303	PRAVEEN KUMAR N
144	411517114304	ROGAN RAJ P
145	411517114305	VIGNESH S
146	411517114306	YOGESHWAR RAO S
147	411517114701	RAJA EBIN S

PERI INSTITUTE OF TECHNOLOGY
Mannivakkam, Chennai 600048
DEPARTMENT OF MECHANICAL ENGINEERING
ACADEMIC YEAR 2018-2019

Participants Name List
Course Name – CATIA

Course Code: MEW005

Year/Semester: III / VIII

Sl. No	Registration Number	Student Name	Sl. No	Registration Number	Student Name
1	411516114003	AJAY KRISHNAN H	26	411516114055	MOHAMED ANWAR A
2	411516114004	AJAY KUMAR P	27	411516114057	MOHANBABU S
3	411516114005	AJESH LIBIN A	28	411516114058	MONESH RAJA R
4	411516114009	ANTROW BAVIN A	29	411516114061	NAGANANTHAN S
5	411516114010	ASHWINKUMAR J	30	411516114062	NAVEEN KUMAR G
6	411516114013	BALAMURUGAN P	31	411516114064	NIRMAL KUMAR R
7	411516114015	CHRISTOB MELBAN S	32	411516114071	RAGHAVARDHAN V
8	411516114016	DHACHENAMOORTHY V	33	411516114072	RAJ S
9	411516114017	DHANAARASU D	34	411516114073	RAMKUMAR K
10	411516114019	DINESH R	35	411516114074	RAVICHANDRAN M
11	411516114020	DINESH KUMAR S	36	411516114078	RITHIK P S
12	411516114022	GOPAL CHOWDARY F	37	411516114080	SAM PRINCE M
13	411516114023	GOPINATH C	38	411516114081	SAMSON F
14	411516114024	GOWTHAM K	39	411516114082	SANTHOSHKUMAR T
15	411516114026	GUNASEKAR M	40	411516114084	SATHISH B
16	411516114028	HARI GANESH R	41	411516114085	SATHIS KUMAR R
17	411516114031	HEMNATH G	42	411516114087	SHAKTHIVEL R
18	411516114035	JAYAPRATHAP E	43	411516114088	SIVAGNANAM A
19	411516114036	JEEVA PENIEL D	44	411516114089	SUNDHAR M
20	411516114037	JEEVESH S	45	411516114092	TAMIZH MANNAN S
21	411516114045	KARTHIKEYAN V G	46	411516114093	THARANEESWAR H
22	411516114046	KEERTHIVASAN R	47	411516114095	VAIDYANATHAN V
23	411516114047	KUMARAN B	48	411516114098	VIGNESH B
24	411516114048	KURALARASAN V	49	411516114102	VIJAYRAJAN V
25	411516114049	LAKSHMI NARAYANAN N	50	411516114103	VINOTH S (29-04-1998)

PERI INSTITUTE OF TECHNOLOGY
Mannivakkam, Chennai 600048
DEPARTMENT OF MECHANICAL ENGINEERING
ACADEMIC YEAR 2018-2019

Participants Name List
Course Name – CATIA

Course Code: MEW005

Year/Semester: III / VI

Sl. No	Registration Number	Student Name
51	411516114104	VINOTH S (03-11-1998)
52	411516114302	CHANDRU R
53	411516114303	JOB A
54	411516114304	KARTHICK E
55	411516114305	MANICKAM D
56	411516114306	NAVEEN KUMAR S
57	411516114307	RAKESH KUMAR SWAIN
58	411516114309	SHAJITH S
59	411516114312	SURENDAR N
60	411516114708	VINOTH V
61	411516114901	THILLAI VENTHAN K
62	411516114002	ABISHEK A
63	411516114006	AJITH A
64	411516114008	AMUDHA RAJ V
65	411516114011	ASHWIN KUMAR R
66	411516114012	BALAJI S
67	411516114014	BALAMURUGAN V
68	411516114021	ELANGO S
69	411516114025	GUKAN J
70	411516114027	GURUMURTHY R
71	411516114029	HARISH K
72	411516114032	JAGADISH M
73	411516114033	JANARTHANAN S
74	411516114034	JAWAHAR SUBBURAJ M
75	411516114039	JOEL RUBERTON R
76	411516114040	JUNIOR NALLATHAMBI K
77	411516114041	KADHARMUGAIDEEN A
78	411516114043	KARMEGAKANNAN N
79	411516114051	MANI K
80	411516114052	MANIKANDAN S

Sl. No	Registration Number	Student Name
81	411516114053	MANOJ KUMAR D
82	411516114054	MERVIN RAJ I
83	411516114056	MOHANARAM R
84	411516114059	MUKESHKUMAR S
85	411516114060	MUKILAN S
86	411516114063	NIJANTHA KUMAR P
87	411516114066	PRAKASH V
88	411516114067	PRASANTH D
89	411516114068	PRASHANTH C
90	411516114069	PRAVEEN S K
91	411516114075	RAVIKUMAR K S
92	411516114076	RENETH B
93	411516114083	SARAVANAN R
94	411516114086	SERBIN S A
95	411516114090	SURESHKUMAR S
96	411516114094	THAVAKKAL T
97	411516114096	VENKATESH R
98	411516114097	VICHITHIRAN P
99	411516114099	VIGNESH M
100	411516114100	VIGNESH R (19-07-98)
101	411516114101	VIGNESH R (19-08-98)
102	411516114301	BHARANI DHARAN A M
103	411516114308	ROHITH C K
104	411516114310	SRINATH R
105	411516114311	SRINIVASAN D
106	411516114313	UDHAYA KUMAR M
107	411516114701	KANNAN K
108	411516114702	SURENDAR R
109	411516114705	SOUNDARARAJAN M
110	411516114707	SATHISH KUMAR S

Coordinator

HOD/MECH

Head of the Department
 Dept. of Mechanical Engg.
 PERI INSTITUTE OF TECH.

PERI INSTITUTE OF TECHNOLOGY
Mannivakkam, Chennai 600048
DEPARTMENT OF MECHANICAL ENGINEERING
ACADEMIC YEAR 2018-2019

Participants Name List
Course Name – CATIA

Course Code: MEW005

Year/Semester: IV / VIII

Sl. No	Registration Number	Student Name
1	411515114001	AADHIRAJAN A
2	411515114002	ABIN ANTO A
3	411515114003	ABINESH N
4	411515114004	AGASSI DANIEL KESARI
5	411515114005	AGILAN K
6	411515114006	AHAMEDBAZEER J
7	411515114007	AJITH KUMAR A
8	411515114008	AKASH N
9	411515114009	AKILAN S
10	411515114010	AKSHAY KRISHNA K S
11	411515114011	ALDRIN PRAKASH D
12	411515114012	ALEX STEVE E
13	411515114013	ANAND S K
14	411515114014	ARUN KUMAR G
15	411515114015	ASHWINNATH SINGH S
16	411515114016	AUGUSTIN JEBARAJ M
17	411515114017	BALAJI B
18	411515114018	BALAJI J
19	411515114019	BALA KUMARAN V
20	411515114020	BALA SUBRAMANIYAN E
21	411515114021	BERLIN B
22	411515114022	BERSLIN SOLOMON A
23	411515114023	BHARATH KUMAR S
24	411515114024	BHUMINATHAN M
25	411515114025	BIJESH P

Sl. No	Registration Number	Student Name
26	411515114026	BIRLA K P
27	411515114027	BOLAS SELVAN J
28	411515114028	BRANDON JUDE PEARL
29	411515114029	BRUCE WINSTON B A
30	411515114030	BRUTUS S
31	411515114031	CHAITHANYA S R
32	411515114032	CHANDRU P
33	411515114033	CHARAN RAJ D
34	411515114034	DANIEL D
35	411515114035	DEVARAJAN D
36	411515114036	DHARANI DHARAN V R
37	411515114037	DHINESH A
38	411515114026	BIRLA K P
39	411515114040	DINESH M (20-08-1997)
40	411515114041	DINESH R
41	411515114042	DINESH ARAVIND K
42	411515114043	DINESHKUMAR M
43	411515114044	DINESH KUMAR M P
44	411515114045	DINESH KUMAR S
45	411515114046	DUVARAKNATH B
46	411515114047	ELUMALAI A
47	411515114048	EMMANUEL JACOB S
48	411515114049	ESHWAR M
49	411515114050	FAIYAZ AHAMED S
50	411515114051	GANESH V

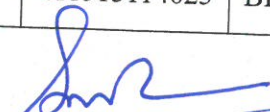
Coordinator

HOD MECH

Head of the Department
 Dept. of Mechanical Engg.
 PERI INSTITUTE OF TECHNOLOGY
 Mannivakkam, Chennai

PERI INSTITUTE OF TECHNOLOGY
Mannivakkam, Chennai 600048
DEPARTMENT OF MECHANICAL ENGINEERING
ACADEMIC YEAR 2018-2019

Participants Name List
Course Name – CATIA

Course Code: MEW005

Year/Semester: IV / VIII

Sl. No	Registration Number	Student Name
51	411515114052	GANESH RAJ M
52	411515114053	GIRIDHARR K
53	411515114054	GIRINATH R
54	411515114055	GOKUL M
55	411515114056	GOKUL R
56	411515114057	GOKULAKRISHNAN P
57	411515114058	GOKULNATH J P
58	411515114059	GOPI KRISHNAN P
59	411515114060	GOPINATH C
60	411515114061	GOPINATH K
61	411515114062	GOPINATH R
62	411515114063	GOUTHAMSHARAN A
63	411515114064	GURUMOORTHY M
64	411515114065	HARENE BABU S
65	411515114066	HARI HARAN G
66	411515114067	HARIHARASUTHAN R
67	411515114068	HARI KRISHNAN S
68	411515114069	HARISH R
69	411515114070	HARISH S
70	411515114071	HARISHANKAR P
71	411515114072	HARISH KUMAR A
72	411515114073	HENSEL WILSON GOVEAS W
73	411515114074	IMMANUEL S
74	411515114075	INDRANIL BANERJEE
75	411515114076	IRFAN BASHA H

Sl. No	Registration Number	Student Name
76	411515114077	IZAZUDDIN T N
77	411515114078	JAMSHEED A M
78	411515114079	JAWAHAR S
79	411515114080	JEBARSON SAMUEL J
80	411515114081	JEEVA A
81	411515114082	JEFRON G
82	411515114083	JEGANNADHAN J M
83	411515114084	JOHN WESLEY V
84	411515114085	JOSHI DAS L R
85	411515114086	KARAN S
86	411515114087	KARTHICK K
87	411515114088	KARTHICK S
88	411515114089	KARTHIK S (05-12-1997)
89	411515114090	KARTHIK S (14-12-1997)
90	411515114091	KARTHIK T
91	411515114092	KARTHIKEYAN K
92	411515114093	KARTHIKEYAN R
93	411515114094	KARTHIKEYAN V
94	411515114095	KARTHIK RAJA J
95	411515114096	KARTHIKSURYA R
96	411515114097	KAVIYARASAN R
97	411515114098	KEERTHI T
98	411515114099	KESHAVRAM S
99	411515114100	KIRISHANTH S
100	411515114101	KOUSHIK A

Coordinator

HOD/MESH

Head of the Department
 Dept. of Mechanical Engg.
 PERI INSTITUTE OF TECH.
 Mannivakkam, Ch-600 048.

PERI INSTITUTE OF TECHNOLOGY
Mannivakkam, Chennai 600048
DEPARTMENT OF MECHANICAL ENGINEERING
ACADEMIC YEAR 2018-2019

Participants Name List
Course Name – CATIA

Course Code: MEW005

Year/Semester: IV / VIII

Sl. No	Registration Number	Student Name
101	411515114102	KOWSHIK S
102	411515114103	KRISHNA PRASATH S
103	411515114104	KUMARESAN A
104	411515114105	LOGARAJAN M
105	411515114106	LOGESHWARAN J
106	411515114107	LOKESH S
107	411515114108	MADHAN S
108	411515114109	MAGESH A
109	411515114110	MAHAVISHNU B
110	411515114111	MANIVANNAN R
111	411515114112	MANOJ S K
112	411515114113	MANOJKUMAR G
113	411515114115	MARIA AJITH NITHIYAN P
114	411515114116	MOHAMED ASRAF A
115	411515114117	MOHAMED RIYAZ M
116	411515114118	MOHAMED SUHAIL H
117	411515114119	MOHAMMED FAIZAL M
118	411515114120	MOHAMMED HABEEBULLAH N
119	411515114121	MOHAN B
120	411515114122	MOHAN G
121	411515114123	MOHAN N
122	411515114124	MULAKATI SAIPRAKASH
123	411515114125	MUTHUSAMY M
124	411515114126	NAVEEN KUMAR A
125	411515114127	NAVEEN KUMAR J

Sl. No	Registration Number	Student Name
126	411515114128	NAVEEN KUMAR M S
127	411515114129	NAVEEN KUMAR V
128	411515114130	NAVIN N
129	411515114131	NIJANDHAN J
130	411515114132	NIKESH C
131	411515114133	NISHANTH M
132	411515114134	NITHISH KUMAR R
133	411515114135	PARAMESHWARAN K
134	411515114136	PARTHASARATHY K
135	411515114137	PARTHASARATHY S
136	411515114138	PARTHEEBAN D
137	411515114139	PAVITHRAN S
138	411515114140	PERIYASAMY S
139	411515114141	PRABAGARAN S
140	411515114142	PRABHU K
141	411515114143	PRADEEP M
142	411515114144	PRADEEP R
143	411515114145	PRADEEP V
144	411515114146	PRAGADEESH V
145	411515114147	PRAKASH G
146	411515114148	PRAKASH K
147	411515114149	PRASANAH KUMAR S K
148	411515114150	PRASANNA S
149	411515114151	PRASANTH S
150	411515114152	PRAVEEN G V

Coordinator

HOD/MECH

Head of the Department
 Dept of Mechanical Engg.
 PERI INSTITUTE OF TECH.
 Mannivakkam, Ch-600 048.

PERI INSTITUTE OF TECHNOLOGY
Mannivakkam, Chennai 600048
DEPARTMENT OF MECHANICAL ENGINEERING
ACADEMIC YEAR 2018-2019

Participants Name List
Course Name – CATIA

Course Code: MEW005

Year/Semester: IV / VIII

Sl. No	Registration Number	Student Name
151	411515114153	PRAVEEN KUMAR D
152	411515114154	PRAVEEN KUMAR P
153	411515114156	PRAVEENRAJ R
154	411515114157	PRAVIN N D
155	411515114158	PREMKUMAR S
156	411515114159	PUVIYARASAN J M
157	411515114160	RAAJIV S
158	411515114161	RAGHURAMA CHANDRAN L
159	411515114162	RAGUL D
160	411515114163	RAHUL RISHI M
161	411515114164	RAJA P
162	411515114165	RAJAGURU V
163	411515114166	RAJ KUMAR M
164	411515114167	RAKESH M
165	411515114168	RAMANATHAN K
166	411515114169	RANJITH A
167	411515114170	RATHISH RAJ R
168	411515114171	RAVICHANDRAN K
169	411515114172	REMI A
170	411515114173	ROHITH RAJENDRAN
171	411515114174	SABAREESH P B
172	411515114175	SABARINATHAN T
173	411515114176	SACHIN PRAKASH R
174	411515114177	SAI PRATAP D
175	411515114178	SAKTHIDHASAN M

Sl. No	Registration Number	Student Name
176	411515114179	SAM JOE J
177	411515114180	SANJEEVI M
178	411515114181	SANTHAKUMAR C
179	411515114182	SANTHOSH C G
180	411515114183	SARAN S
181	411515114185	SATHISH M
182	411515114186	SATHISH R
183	411515114188	SATHISH KUMAR S (30-07-1998)
184	411515114189	SATHYANARAYANAN S
185	411515114190	SATHYA NARAYANAN D
186	411515114191	SAURAV KUMAR
187	411515114192	SELVARAJ S
188	411515114193	SEZHIYAN P
189	411515114194	SHAMER BIN HUSSAIN M
190	411515114195	SHIVANESAN B
191	411515114196	SIMIYON SAMUVEL E
192	411515114197	SIVA E
193	411515114198	SIVAMANIKANADAN M
194	411515114199	SIVASANKARAN R
195	411515114200	SRIKARTHICK A
196	411515114201	SRIRAM R
197	411515114202	SUBASH K
198	411515114203	SUDIR S
199	411515114204	SUKRAM M
200	411515114205	SUNDAREESHWARAN J

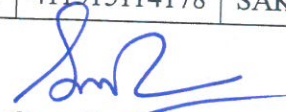
Coordinator

HOD/MECH

Head of the Department
 Dept of Mechanical Engg.
 PERI INSTITUTE OF TECH.
 Mannivakkam, Ch. 600 048.

PERI INSTITUTE OF TECHNOLOGY
Mannivakkam, Chennai 600048
DEPARTMENT OF MECHANICAL ENGINEERING
ACADEMIC YEAR 2018-2019
Participants Name List
Course Name – CATIA

Course Code: MA005

Year/Semester: IV / 8

Sl. No	Registration Number	Student Name
201	411515114206	SURENDAR R
202	411515114207	SURENDAR S
203	411515114208	SURESH B
204	411515114209	SURESH T
205	411515114210	SURYA M
206	411515114211	SURYA PRASATH G S
207	411515114212	SYED SADDAM ALI
208	411515114213	TAMILSELVAN S
209	411515114214	TAMILVANAN S
210	411515114215	THIRUMALAI E
211	411515114216	THIYAGARAJAN V
212	411515114217	UDHAYA KUMAR A
213	411515114218	VASUMADHAN V
214	411515114219	VIGASH R
215	411515114220	VIGNESH G
216	411515114221	VIGNESH K
217	411515114222	VIGNESH M
218	411515114223	VIGNESH S
219	411515114224	VIGNESH V
220	411515114225	VIGNESH KUMAR S
221	411515114227	VIJAY R
222	411515114228	VIJAYAKUMAR R

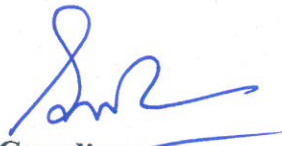
Coordinator

HOD/MECH

Head of the Department
Dept. of Mechanical Engg.
PERI INSTITUTE OF TECH.
Mannivakkam, Ch-600 048.

PERI INSTITUTE OF TECHNOLOGY
Mannivakkam, Chennai 600048
DEPARTMENT OF MECHANICAL ENGINEERING
ACADEMIC YEAR 2018-2019

Attendance Sheet
Course Name: CATIA

Course Code: MEW005

Year/Semester: II,III,IV / IV,VI,VIII

Sl. No	Registration Number	Student Name	22.03.19	30.03.19	20.04.19	27.04.19	04.05.19
Second Year							
1	411517114001	AADESH M	Adesh	Adesh	Adesh	Adesh	Adesh
2	411517114002	ABDUL HAMEED A	Abdul	Abdul	Abdul	Abdul	Abdul
3	411517114003	ABINESH C	Abin	Abin	Abin	Abin	Abin
4	411517114004	ABISHEK M (19-05-1999)	Abi	Abi	Abi	Abi	Abi
5	411517114005	ABISHEK M (16-06-2000)	Abi	Abi	Abi	Abi	Abi
6	411517114007	AJAY K	Ajay	Ajay	Ajay	Ajay	Ajay
7	411517114008	AJAY R	Ajay	Ajay	Ajay	Ajay	Ajay
8	411517114009	AJAY MUGIL V	Ajay	Ajay	Ajay	Ajay	Ajay
9	411517114010	AJAY RAJ KUMAR G	Ajay Raj	Ajay Raj	Ajay Raj	Ajay Raj	Ajay Raj
10	411517114011	AJAY VISHWA V	Ajay	Ajay	Ajay	Ajay	Ajay
11	411517114012	AJITHKUMAR S	Ajay	Ajay	Ajay	Ajay	Ajay
12	411517114013	AKASH C	Akash	Akash	Akash	Akash	Akash
13	411517114014	AKASH S	Akash	Akash	Akash	Akash	Akash
14	411517114016	AKASH S	Akash	Akash	Akash	Akash	Akash
15	411517114017	ALFRED ROSHAN M	Alfred	Alfred	Alfred	Alfred	Alfred
16	411517114018	ANANDHA KRISHNAN M	Anand	Anand	Anand	Anand	Anand
17	411517114019	ANISH R	Anish	Anish	Anish	Anish	Anish
18	411517114020	ANNAMALAI S	Annam	Annam	Annam	Annam	Annam
19	411517114021	ANTO PRINCE P	Anto	Anto	Anto	Anto	Anto
20	411517114022	APPANDAIRAJ S	Appan	Appan	Appan	Appan	Appan
21	411517114024	ARAVIND E B	Aravind	Aravind	Aravind	Aravind	Aravind
22	411517114025	ARAVINDA KUMAR M	Aravind	Aravind	Aravind	Aravind	Aravind
23	411517114026	ARAVIND KUMAR S	Aravind	Aravind	Aravind	Aravind	Aravind
24	411517114027	ARUL ANANDHAM A S	Arul	Arul	Arul	Arul	Arul
25	411517114028	ARUN A S	Arun	Arun	Arun	Arun	Arun

26	411517114029	ARUNKUMAR S	Arun	Arun	Arun	Arun	Arun
27	411517114030	ARUN KUMAR V	Arun	Arun	Arun	Arun	Arun
28	411517114033	BALAJI S (18-06-99) S	Balaji	Balaji	Balaji	Balaji	Balaji
29	411517114034	BALAJI S (25-10-1999) S	Balaji	Balaji	Balaji	Balaji	Balaji
30	411517114035	BARATH A	Barath	Barath	Barath	Barath	Barath
31	411517114039	BHARATH P	Bharath	Bharath	Bharath	Bharath	Bharath
32	411517114040	BUVANESHWAR A	Buvan	Buvan	Buvan	Buvan	Buvan
33	411517114041	CAJETAN RAHUL S A	Chetan	Chetan	Chetan	Chetan	Chetan
34	411517114043	CHERUKURU TEJA	Cheru	Cheru	Cheru	Cheru	Cheru
35	411517114044	DHANUSH E	Dhanush	Dhanush	Dhanush	Dhanush	Dhanush
36	411517114045	DHARUN NIVAS S N	Dharun	Dharun	Dharun	Dharun	Dharun
37	411517114046	DINESH A	Dinesh	Dinesh	Dinesh	Dinesh	Dinesh
38	411517114047	DINESH B	Dinesh	Dinesh	Dinesh	Dinesh	Dinesh
39	411517114049	DINESH KUMAR C	Dinesh	Dinesh	Dinesh	Dinesh	Dinesh
40	411517114050	DIVYACHANDAR S	Diva	Diva	Diva	Diva	Diva
41	411517114051	ELUMALAI A	Elum	Elum	Elum	Elum	Elum
42	411517114052	FERNANDES K	Fern	Fern	Fern	Fern	Fern
43	411517114054	GOKULARAJA S	Gokul	Gokul	Gokul	Gokul	Gokul
44	411517114055	GOKUL HARSHA P	Gokul	Gokul	Gokul	Gokul	Gokul
45	411517114056	GOPESHWARAN A	Gopesh	Gopesh	Gopesh	Gopesh	Gopesh
46	411517114057	GOWTHAM N	Gowtham	Gowtham	Gowtham	Gowtham	Gowtham
47	411517114058	GOWTHAM RAJA M	Gowtham	Gowtham	Gowtham	Gowtham	Gowtham
48	411517114059	HARIHARAN B	Hariharan	Hariharan	Hariharan	Hariharan	Hariharan
49	411517114060	HARISH V	Harish	Harish	Harish	Harish	Harish
50	411517114063	JAGADEESH G	Jagadeesh	Jagadeesh	Jagadeesh	Jagadeesh	Jagadeesh
51	411517114064	JAIADITHIYAN P	Jaiadithiyan	Jaiadithiyan	Jaiadithiyan	Jaiadithiyan	Jaiadithiyan
52	411517114067	KAMALESH E	Kamalesh	Kamalesh	Kamalesh	Kamalesh	Kamalesh
53	411517114068	KARAN SINGH J	Karan Singh	Karan Singh	Karan Singh	Karan Singh	Karan Singh
54	411517114070	KARTHICKKUMAR S	Karthick	Karthick	Karthick	Karthick	Karthick
55	411517114071	KARTHIKEYAN R	Karthikeyan	Karthikeyan	Karthikeyan	Karthikeyan	Karthikeyan
56	411517114072	KARUPPASAMY A	Karuppasamy	Karuppasamy	Karuppasamy	Karuppasamy	Karuppasamy
57	411517114073	KAVIARASAN J	Kaviarasan	Kaviarasan	Kaviarasan	Kaviarasan	Kaviarasan

58	411517114075	LOGESHWARAN S	Logesh	Logesh	Logesh	Logesh	Logesh
59	411517114076	LOKESH S	Lokesh	Lokesh	Lokesh	Lokesh	Lokesh
60	411517114077	MADAN JASWANT RAHUL S	Madhan	Madhan	Madhan	Madhan	Madhan
61	411517114078	MADHAVAN M	Madhan	Madhan	Madhan	Madhan	Madhan
62	411517114079	MANICKAVASAGAR S	Manick	Manick	Manick	Manick	Manick
63	411517114080	MANIKANDAN C	Mani	Mani	Mani	Mani	Mani
64	411517114083	MANISH KUMAR R	Manish	Manish	Manish	Manish	Manish
65	411517114084	MANOJ G	Manoj	Manoj	Manoj	Manoj	Manoj
66	411517114085	MANOJ KUMAR A	Manoj	Manoj	Manoj	Manoj	Manoj
67	411517114086	MANYAM R CHARAN	Manyan	Manyan	Manyan	Manyan	Manyan
68	411517114087	MARTIN ROY S	Martin	Martin	Martin	Martin	Martin
69	411517114088	MESHACH NEERAJ P V	Meshach	Meshach	Meshach	Meshach	Meshach
70	411517114089	MITHUNA SRINIKA A	Mithun	Mithun	Mithun	Mithun	Mithun
71	411517114091	MOHAMMED ABUL FATHAH Z	Mohammed	Mohammed	Mohammed	Mohammed	Mohammed
72	411517114092	MOOVENDHAN V	Moo	Moo	Moo	Moo	Moo
73	411517114093	MOSES JEBARAJ A	Moses	Moses	Moses	Moses	Moses
74	411517114094	MUGESH KANNAN M	Mugesh	Mugesh	Mugesh	Mugesh	Mugesh
75	411517114095	MUHAMMAD YASAR ARAFATH S	Muhammad	Muhammad	Muhammad	Muhammad	Muhammad
76	411517114096	MUKESHKUMAR S	Mukesh	Mukesh	Mukesh	Mukesh	Mukesh
77	411517114097	MUTHURAMALINGA M V	Muthu	Muthu	Muthu	Muthu	Muthu
78	411517114098	MUZAFAR AHAMED F	Muzafar	Muzafar	Muzafar	Muzafar	Muzafar
79	411517114099	NAKKEERAN N	Nakkeeran	Nakkeeran	Nakkeeran	Nakkeeran	Nakkeeran
80	411517114100	NATARAJAN G	Natarajan	Natarajan	Natarajan	Natarajan	Natarajan
81	411517114101	NEHRU T	Nehru	Nehru	Nehru	Nehru	Nehru
82	411517114102	NITHISH KUMAR S	Nithish	Nithish	Nithish	Nithish	Nithish
83	411517114103	PALANI S	Palani	Palani	Palani	Palani	Palani
84	411517114104	PALANIVEL RAJA K	Palani	Palani	Palani	Palani	Palani
85	411517114105	PALLAVARAJ V	Pallavaraj	Pallavaraj	Pallavaraj	Pallavaraj	Pallavaraj
86	411517114106	PARVENDHAN T	Parvendhan	Parvendhan	Parvendhan	Parvendhan	Parvendhan
87	411517114107	PATURU VISHAL	Paturu	Paturu	Paturu	Paturu	Paturu

88	411517114108	PAVITHRAN S	Pav	Pav	Pav	Pav	Pav
89	411517114110	PRABAKARAN J	Prab	Prab	Prab	Prab	Prab
90	411517114111	PRADEEP KUMAR K	Pradeep	Pradeep	Pradeep	Pradeep	Pradeep
91	411517114112	PRAVEEN KUMAR J	Praveen	Praveen	Praveen	Praveen	Praveen
92	411517114113	PRAVEEN KUMAR M	Praveen	Praveen	Praveen	Praveen	Praveen
93	411517114114	PRAVEEN KUMAR S (03-03-1999)	Pra	Pra	Pra	Pra	Pra
94	411517114115	PRAVEEN KUMAR S (08-04-2000)	Praveen	Praveen	Praveen	Praveen	Praveen
95	411517114116	PRAVINKUMAR K	Pravin	Pravin	Pravin	Pravin	Pravin
96	411517114117	PREM KUMAR J	Prem	Prem	Prem	Prem	Prem
97	411517114118	PRIYESH P	Priyesh	Priyesh	Priyesh	Priyesh	Priyesh
98	411517114119	RAGHU D	Raghu	Raghu	Raghu	Raghu	Raghu
99	411517114120	RAGUL R	Ragul	Ragul	Ragul	Ragul	Ragul
100	411517114122	RAMANAIAH CV	Rama	Rama	Rama	Rama	Rama
101	411517114124	RAVI KUMARAN K	Ravi	Ravi	Ravi	Ravi	Ravi
102	411517114125	REVANTH S	Revanth	Revanth	Revanth	Revanth	Revanth
103	411517114126	RISIKESH K	Risikesh	Risikesh	Risikesh	Risikesh	Risikesh
104	411517114127	SABARI A	Sabari	Sabari	Sabari	Sabari	Sabari
105	411517114128	SABBE SATHVIK	Sabbe	Sabbe	Sabbe	Sabbe	Sabbe
106	411517114129	SAI BHARGAV K	Sai	Sai	Sai	Sai	Sai
107	411517114130	SAKTHI ANAND R	Sakthi	Sakthi	Sakthi	Sakthi	Sakthi
108	411517114131	SAKTHIVEL E	Sakthivel	Sakthivel	Sakthivel	Sakthivel	Sakthivel
109	411517114132	SANDHIYA T	Sandhya	Sandhya	Sandhya	Sandhya	Sandhya
110	411517114134	SATHISH J	Sathish	Sathish	Sathish	Sathish	Sathish
111	411517114135	SATHISHKUMAR S	Sathish	Sathish	Sathish	Sathish	Sathish
112	411517114136	SELVADURAI C	Selva	Selva	Selva	Selva	Selva
113	411517114137	SELVAM P	Selvam	Selvam	Selvam	Selvam	Selvam
114	411517114138	SENTHAMILAN K	Senth	Senth	Senth	Senth	Senth
115	411517114140	SOBIKA S	Sobika	Sobika	Sobika	Sobika	Sobika
116	411517114142	SONU PRASAAD H	Sonu	Sonu	Sonu	Sonu	Sonu
117	411517114143	SREEVATHSAN B	Sree	Sree	Sree	Sree	Sree
118	411517114144	SRIDHAR S	Sridhar	Sridhar	Sridhar	Sridhar	Sridhar
119	411517114145	SUDHEER V	Sudheer	Sudheer	Sudheer	Sudheer	Sudheer

120	411517114146	SUGUMARAN K	Suu	Suu	Suu	Suu	Suu
121	411517114147	SULTHAN BASHA A	Sultana	Sultan	Sultan	Sultan	Sultan
122	411517114148	SURESH KUMAR S	Suresh	Suresh	Suresh	Suresh	Suresh
123	411517114149	SURIYA K	Surya	Surya	Surya	Surya	Surya
124	411517114150	SYED NAZEEF	Syed	Syed	Syed	Syed	Syed
125	411517114151	THENNARASU R	THENNAR	THENNAR	THENNAR	THENNAR	THENNAR
126	411517114152	THIYAGU C	Thiyagu	Thiyagu	Thiyagu	Thiyagu	Thiyagu
127	411517114154	THULACI RAMAN R	Thulaci	Thulaci	Thulaci	Thulaci	Thulaci
128	411517114155	UDATHA MYTHRESH SAI MAHADEV	Udatha	Udatha	Udatha	Udatha	Udatha
129	411517114156	VASANTHA KUMAR S	Vasanth	Vasanth	Vasanth	Vasanth	Vasanth
130	411517114157	VIGNESH A	Vignesh	Vignesh	Vignesh	Vignesh	Vignesh
131	411517114158	VIGNESH G (21-12-1999)	Vignesh	Vignesh	Vignesh	Vignesh	Vignesh
132	411517114159	VIGNESH G (23-12-1999)	Vignesh	Vignesh	Vignesh	Vignesh	Vignesh
133	411517114160	VIGNESH P	Vignesh	Vignesh	Vignesh	Vignesh	Vignesh
134	411517114161	VIGNESH R	Vignesh	Vignesh	Vignesh	Vignesh	Vignesh
135	411517114162	VIGNESHWARAN K	Vignesh	Vignesh	Vignesh	Vignesh	Vignesh
136	411517114164	VIKRAM P	Vikram	Vikram	Vikram	Vikram	Vikram
137	411517114165	VIKRAMAN T	Vikraman	Vikraman	Vikraman	Vikraman	Vikraman
138	411517114168	YASAR ARUN S	Yasar	Yasar	Yasar	Yasar	Yasar
139	411517114169	YUVAPRASATH B	Yuvapr	Yuvapr	Yuvapr	Yuvapr	Yuvapr
140	411517114170	YVESRON P	Yvesron	Yvesron	Yvesron	Yvesron	Yvesron
141	411517114301	ARUN KUMAR G	Arun	Arun	Arun	Arun	Arun
142	411517114302	GANGADHARAN K	Ganga	Gangadharan	Gangadharan	Gangadharan	Gangadharan
143	411517114303	PRAVEEN KUMAR N	Praveen	Praveen	Praveen	Praveen	Praveen
144	411517114304	ROGAN RAJ P	Rogan	Rogan	Rogan	Rogan	Rogan
145	411517114305	VIGNESH S	Vignesh	Vignesh	Vignesh	Vignesh	Vignesh
146	411517114306	YOGESHWAR RAO S	Yogeshwar	Yogeshwar	Yogeshwar	Yogeshwar	Yogeshwar
147	411517114701	RAJA EBIN S	Raja	Raja	Raja	Raja	Raja

Third Year

1	411516114003	AJAY KRISHNAN H	Ajay	Ajay	Ajay	Ajay	Ajay
2	411516114004	AJAY KUMAR P	Ajay	Ajay	Ajay	Ajay	Ajay
3	411516114005	AJESH LIBIN A	Ajesh	Ajesh	Ajesh	Ajesh	Ajesh
4	411516114009	ANTROW BAVIN A	Antrow	Antrow	Antrow	Antrow	Antrow
5	411516114010	ASHWINKUMAR J	Ashwin	Ashwin	Ashwin	Ashwin	Ashwin
6	411516114013	BALAMURUGAN P	Balamu	Balamu	Balamu	Balamu	Balamu
7	411516114015	CHRISTOB MELBAN S	Christob	Christob	Christob	Christob	Christob
8	411516114016	DHACHENAMOOR THY V	Dhach	Dhach	Dhach	Dhach	Dhach
9	411516114017	DHANAARASU D	Dhana	Dhana	Dhana	Dhana	Dhana
10	411516114019	DINESH R	Dinesh	Dinesh	Dinesh	Dinesh	Dinesh
11	411516114020	DINESH KUMAR S	Dinesh	Dinesh	Dinesh	Dinesh	Dinesh
12	411516114022	GOPAL CHOWDARY F	Gopal	Gopal	Gopal	Gopal	Gopal
13	411516114023	GOPINATH C	Gopinath	Gopinath	Gopinath	Gopinath	Gopinath
14	411516114024	GOWTHAM K	Gowtham	Gowtham	Gowtham	Gowtham	Gowtham
15	411516114026	GUNASEKAR M	Gunase	Gunase	Gunase	Gunase	Gunase
16	411516114028	HARI GANESH R	Hari	Hari	Hari	Hari	Hari
17	411516114031	HEMNATH G	Hemnath	Hemnath	Hemnath	Hemnath	Hemnath
18	411516114035	JAYAPRATHAP E	Jayaprath	Jayaprath	Jayaprath	Jayaprath	Jayaprath
19	411516114036	JEEVA PENIEL D	Jeeva	Jeeva	Jeeva	Jeeva	Jeeva
20	411516114037	JEEVESH S	Jeevesh	Jeevesh	Jeevesh	Jeevesh	Jeevesh
21	411516114045	KARTHIKEYAN V G	Karthikey	Karthikey	Karthikey	Karthikey	Karthikey
22	411516114046	KEERTHIVASAN R	Keerthivas	Keerthivas	Keerthivas	Keerthivas	Keerthivas
23	411516114047	KUMARAN B	Kumaran	Kumaran	Kumaran	Kumaran	Kumaran
24	411516114048	KURALARASAN V	Kuralaras	Kuralaras	Kuralaras	Kuralaras	Kuralaras
25	411516114049	LAKSHMI NARAYANAN N	Lakshmi	Lakshmi	Lakshmi	Lakshmi	Lakshmi
26	411516114055	MOHAMED ANWAR A	Mohamed	Mohamed	Mohamed	Mohamed	Mohamed
27	411516114057	MOHANBABU S	Mohanbabu	Mohanbabu	Mohanbabu	Mohanbabu	Mohanbabu
28	411516114058	MONESH RAJA R	Monesh	Monesh	Monesh	Monesh	Monesh
29	411516114061	NAGANANTHAN S	Nagananth	Nagananth	Nagananth	Nagananth	Nagananth
30	411516114062	NAVEEN KUMAR G	Naveen	Naveen	Naveen	Naveen	Naveen
31	411516114064	NIRMAL KUMAR R	Nirmal	Nirmal	Nirmal	Nirmal	Nirmal
32	411516114071	RAGHAVARDHAN V	Raghavardh	Raghavardh	Raghavardh	Raghavardh	Raghavardh
33	411516114072	RAJ S	Raj	Raj	Raj	Raj	Raj
34	411516114073	RAMKUMAR K	Ramkumar	Ramkumar	Ramkumar	Ramkumar	Ramkumar
35	411516114074	RAVICHANDRAN M	Ravichandr	Ravichandr	Ravichandr	Ravichandr	Ravichandr
36	411516114078	RITHIK P S	Rithik	Rithik	Rithik	Rithik	Rithik
37	411516114080	SAM PRINCE M	Sam	Sam	Sam	Sam	Sam

38	411516114081	SAMSON F	Sam	Sam	Sam	Sam	Sam
39	411516114082	SANTHOSHKUMAR T	Santhosh	Santhosh	Santhosh	Santhosh	Santhosh
40	411516114084	SATHISH B	Sathish	Sathish	Sathish	Sathish	Sathish
41	411516114085	SATHIS KUMAR R	Sathis	Sathis	Sathis	Sathis	Sathis
42	411516114087	SHAKTHIVEL R	Shakthivel	Shakthivel	Shakthivel	Shakthivel	Shakthivel
43	411516114088	SIVAGNANAM A	Sivagnanam	Sivagnanam	Sivagnanam	Sivagnanam	Sivagnanam
44	411516114089	SUNDHAR M	Sundhar	Sundhar	Sundhar	Sundhar	Sundhar
45	411516114092	TAMIZH MANNAN S	Tamizh	Tamizh	Tamizh	Tamizh	Tamizh
46	411516114093	THARANEESWAR H	Tharaneeswar	Tharaneeswar	Tharaneeswar	Tharaneeswar	Tharaneeswar
47	411516114095	VAIDYANATHAN V	Vaidyanathan	Vaidyanathan	Vaidyanathan	Vaidyanathan	Vaidyanathan
48	411516114098	VIGNESH B	Vignesh	Vignesh	Vignesh	Vignesh	Vignesh
49	411516114102	VIJAYRAJAN V	Vijayarajan	Vijayarajan	Vijayarajan	Vijayarajan	Vijayarajan
50	411516114103	VINOTH S (29-04-1998)	Vinodh	Vinodh	Vinodh	Vinodh	Vinodh
51	411516114104	VINOTH S (03-11-1998)	Vinodh	Vinodh	Vinodh	Vinodh	Vinodh
52	411516114302	CHANDRU R	Chandru	Chandru	Chandru	Chandru	Chandru
53	411516114303	JOB A	Joba	Joba	Joba	Joba	Joba
54	411516114304	KARTHICK E	Karthick	Karthick	Karthick	Karthick	Karthick
55	411516114305	MANICKAM D	Manickam	Manickam	Manickam	Manickam	Manickam
56	411516114306	NAVEEN KUMAR S	Naveen	Naveen	Naveen	Naveen	Naveen
57	411516114307	RAKESH KUMAR SWAIN	Rakesh	Rakesh	Rakesh	Rakesh	Rakesh
58	411516114309	SHAJITH S	Shajith	Shajith	Shajith	Shajith	Shajith
59	411516114312	SURENDAR N	Suren	Suren	Suren	Suren	Suren
60	411516114708	VINOTH V	Vinodh	Vinodh	Vinodh	Vinodh	Vinodh
61	411516114901	THILLAI VENTHAN K	Thillai	Thillai	Thillai	Thillai	Thillai
62	411516114002	ABISHEK A	Abhishek	Abhishek	Abhishek	Abhishek	Abhishek
63	411516114006	AJITH A	Ajith	Ajith	Ajith	Ajith	Ajith
64	411516114008	AMUDHARAJ V	Amudharaj	Amudharaj	Amudharaj	Amudharaj	Amudharaj
65	411516114011	ASHWIN KUMAR R	Ashwin	Ashwin	Ashwin	Ashwin	Ashwin
66	411516114012	BALAJI S	Balaji	Balaji	Balaji	Balaji	Balaji
67	411516114014	BALAMURUGAN V	Balamurugan	Balamurugan	Balamurugan	Balamurugan	Balamurugan
68	411516114021	ELANGO S	Elango	Elango	Elango	Elango	Elango
69	411516114025	GUKAN J	Gukan	Gukan	Gukan	Gukan	Gukan
70	411516114027	GURUMURTHY R	Gurumurthy	Gurumurthy	Gurumurthy	Gurumurthy	Gurumurthy
71	411516114029	HARISH K	Harish	Harish	Harish	Harish	Harish
72	411516114032	JAGADISH M	Jagadish	Jagadish	Jagadish	Jagadish	Jagadish
73	411516114033	JANARTHANAN S	Janarthan	Janarthan	Janarthan	Janarthan	Janarthan
74	411516114034	JAWAHAR SUBBURAJ M	Jawahar	Jawahar	Jawahar	Jawahar	Jawahar
75	411516114039	JOEL RUBERTON	Joel	Joel	Joel	Joel	Joel

		R						
76	411516114040	JUNIOR NALLATHAMBI K	ju	fu	sa	fa	fu	
77	411516114041	KADHARMUGAIDENA	ka	ka	ka	ka	ka	
78	411516114043	KARMEGAKANNAN N	ka	ka	ka	ka	ka	
79	411516114051	MANI K	ma	ma	ma	ma	ma	
80	411516114052	MANIKANDAN S	ma	ma	ma	ma	ma	
81	411516114053	MANOJ KUMAR D	ma	ma	ma	ma	ma	
82	411516114054	MERVIN RAJ I	me	me	me	me	me	
83	411516114056	MOHANA RAM R	mo	mo	mo	mo	mo	
84	411516114059	MUKESHKUMAR S	mu	mu	mu	mu	mu	
85	411516114060	MUKILAN S	mu	mu	mu	mu	mu	
86	411516114063	NIJANTHA KUMAR P	ni	ni	ni	ni	ni	
87	411516114066	PRAKASH V	pra	pra	pra	pra	pra	
88	411516114067	PRASANTH D	pra	pra	pra	pra	pra	
89	411516114068	PRASHANTH C	pra	pra	pra	pra	pra	
90	411516114069	PRAVEEN S K	pra	pra	pra	pra	pra	
91	411516114075	RAVIKUMAR K S	ra	ra	ra	ra	ra	
92	411516114076	RENETH B	re	re	re	re	re	
93	411516114083	SARAVANAN R	sa	sa	sa	sa	sa	
94	411516114086	SERBIN SA	se	se	se	se	se	
95	411516114090	SURESHKUMAR S	su	su	su	su	su	
96	411516114094	THAVAKKAL T	tha	tha	tha	tha	tha	
97	411516114096	VENKATESH R	ve	ve	ve	ve	ve	
98	411516114097	VICHITHIRAN P	vi	vi	vi	vi	vi	
99	411516114099	VIGNESH M	vi	vi	vi	vi	vi	
100	411516114100	VIGNESH R (19-07-98)	vi	vi	vi	vi	vi	
101	411516114101	VIGNESH R (19-08-98)	vi	vi	vi	vi	vi	
102	411516114301	BHARANI DHARANAM	ba	ba	ba	ba	ba	
103	411516114308	ROHITH C K	ro	ro	ro	ro	ro	
104	411516114310	SRINATH R	sr	sr	sr	sr	sr	
105	411516114311	SRINIVASAN D	sr	sr	sr	sr	sr	
106	411516114313	UDHAYA KUMAR M	ud	ud	ud	ud	ud	
107	411516114701	KANNAN K	ka	ka	ka	ka	ka	
108	411516114702	SURENDAR R	su	su	su	su	su	
109	411516114705	SOUNDARARAJAN M	su	su	su	su	su	
110	411516114707	SATHISH KUMAR S	sa	sa	sa	sa	sa	

Final Year							
1	411515114001	AADHIRAJAN A	Adh	Adh	Adh	Adh	Adh
2	411515114002	ABIN ANTO A	Abin	Abin	Abin	Abin	Abin
3	411515114003	ABINESH N	Abin	Abin	Abin	Abin	Abin
4	411515114004	AGASSI DANIEL KESARI	Agassi	Agassi	Agassi	Agassi	Agassi
5	411515114005	AGILAN K	Agil	Agil	Agil	Agil	Agil
6	411515114006	AHAMEDBAZEER J	Ahmed	Ahmed	Ahmed	Ahmed	Ahmed
7	411515114007	AJITH KUMAR A	Ajith	Ajith	Ajith	Ajith	Ajith
8	411515114008	AKASH N	Akash	Akash	Akash	Akash	Akash
9	411515114009	AKILAN S	Akila	Akila	Akila	Akila	Akila
10	411515114010	AKSHAY KRISHNA K S	Akshay	Akshay	Akshay	Akshay	Akshay
11	411515114011	ALDRIN PRAKASH D	Aldrin	Aldrin	Aldrin	Aldrin	Aldrin
12	411515114012	ALEX STEVE E	Alex	Alex	Alex	Alex	Alex
13	411515114013	ANAND S K	Anand	Anand	Anand	Anand	Anand
14	411515114014	ARUN KUMAR G	Arun	Arun	Arun	Arun	Arun
15	411515114015	ASHWINNATH SINGH S	Ashwin	Ashwin	Ashwin	Ashwin	Ashwin
16	411515114016	AUGUSTIN JEBARA M	Augustin	Augustin	Augustin	Augustin	Augustin
17	411515114017	BALAJI B	Balaji	Balaji	Balaji	Balaji	Balaji
18	411515114018	BALAJI J	Balaji	Balaji	Balaji	Balaji	Balaji
19	411515114019	BALA KUMARAN V	Bala	Bala	Bala	Bala	Bala
20	411515114020	BALA SUBRAMANIYAN E	Bala	Bala	Bala	Bala	Bala
21	411515114021	BERLIN B	Berlin	Berlin	Berlin	Berlin	Berlin
22	411515114022	BERSLIN SOLOMON A	Berlin	Berlin	Berlin	Berlin	Berlin
23	411515114023	BHARATH KUMAR S	Bharath	Bharath	Bharath	Bharath	Bharath
24	411515114024	BHUMINATHAN M	Bhumin	Bhumin	Bhumin	Bhumin	Bhumin
25	411515114025	BIJESH P	Bijesh	Bijesh	Bijesh	Bijesh	Bijesh
26	411515114026	BIRLA K P	Birla	Birla	Birla	Birla	Birla
27	411515114027	BOLAS SELVAN J	Bolas	Bolas	Bolas	Bolas	Bolas

28	411515114028	BRANDON JUDE PEARL	Brd	Brd	Brd	Brd	Brd
29	411515114029	BRUCE WINSTON B A	Brd	Brd	Brd	Brd	Brd
30	411515114030	BRUTUS S	Brd	Brd	Brd	Brd	Brd
31	411515114031	CHAITHANYA S R	Chf	Chf	Chf	Chf	Chf
32	411515114032	CHANDRU P	Chnd	Chnd	Chnd	Chnd	Chnd
33	411515114033	CHARAN RAJ D	Chrd	Chrd	Chrd	Chrd	Chrd
34	411515114034	DANIEL D	Dnl	Dnl	Dnl	Dnl	Dnl
35	411515114035	DEVARAJAN D	Dvr	Dvr	Dvr	Dvr	Dvr
36	411515114036	DHARANI DHARAN V R	Dhr	Dhr	Dhr	Dhr	Dhr
37	411515114037	DHINESH A	Dhns	Dhns	Dhns	Dhns	Dhns
38	411515114026	BIRLA K P	Bird	Bird	Bird	Bird	Bird
39	411515114040	DINESH M (20-08-1997)	Dns	Dns	Dns	Dns	Dns
40	411515114041	DINESH R	Dnr	Dnr	Dnr	Dnr	Dnr
41	411515114042	DINESH ARAVIND K	ADAK	ADAK	ADAK	ADAK	ADAK
42	411515114043	DINESHKUMAR M	Dnd	Dnd	Dnd	Dnd	Dnd
43	411515114044	DINESH KUMAR M P	Dsd	Dsd	Dsd	Dsd	Dsd
44	411515114045	DINESH KUMAR S	Dsf	Dsf	Dsf	Dsf	Dsf
45	411515114046	DUVARAKNATH B	Dvrb	Dvrb	Dvrb	Dvrb	Dvrb
46	411515114047	ELUMALAI A	elm	elm	elm	elm	elm
47	411515114048	EMMANUEL JACOB S	Jms	Jms	Jms	Jms	Jms
48	411515114049	ESHWAR M	Estwar	Estwar	Estwar	Estwar	Estwar
49	411515114050	FAIYAZ AHAMED S	Fyf	Fyf	Fyf	Fyf	Fyf
50	411515114051	GANESH V	Gvsh	Gvsh	Gvsh	Gvsh	Gvsh
51	411515114052	GANESH RAJ M	Gvsh Raj	Gvsh Raj	Gvsh Raj	Gvsh Raj	Gvsh Raj
52	411515114053	GIRIDHARR K	Gvsh	Gvsh	Gvsh	Gvsh	Gvsh
53	411515114054	GIRINATH R	Gvsh	Gvsh	Gvsh	Gvsh	Gvsh
54	411515114055	GOKUL M	Gvsh	Gvsh	Gvsh	Gvsh	Gvsh
55	411515114056	GOKUL R	Gvsh	Gvsh	Gvsh	Gvsh	Gvsh
56	411515114057	GOKULAKRISHNA N P	Gvsh	Gvsh	Gvsh	Gvsh	Gvsh
57	411515114058	GOKULNATH J P	Gvsh	Gvsh	Gvsh	Gvsh	Gvsh
58	411515114059	GOPI KRISHNAN P	Gvsh	Gvsh	Gvsh	Gvsh	Gvsh
59	411515114060	GOPINATH C	Gopinath	Gopinath	Gopinath	Gopinath	Gopinath
60	411515114061	GOPINATH K	Gvsh	Gvsh	Gvsh	Gvsh	Gvsh

61	411515114062	GOPINATH R	Gopi	Gopi	Gopi	Gopi	Gopi
62	411515114063	GOUTHAMSHARANA	Gou	Gou	Gou	Gou	Gou
63	411515114064	GURUMOORTHY M	Guru	Guru	Guru	Guru	Guru
64	411515114065	HARENE BABU S	Hare	Hare	Hare	Hare	Hare
65	411515114066	HARI HARAN G	Hari	Hari	Hari	Hari	Hari
66	411515114067	HARIHARASUTHAN R	Hari	Hari	Hari	Hari	Hari
67	411515114068	HARI KRISHNAN S	Hari	Hari	Hari	Hari	Hari
68	411515114069	HARISH R	Hari	Hari	Hari	Hari	Hari
69	411515114070	HARISH S	Hari	Hari	Hari	Hari	Hari
70	411515114071	HARISHANKAR P	Hari	Hari	Hari	Hari	Hari
71	411515114072	HARISH KUMARA	Hari	Hari	Hari	Hari	Hari
72	411515114073	HENSEL WILSON GOVEAS W	Hens	Hens	Hens	Hens	Hens
73	411515114074	IMMANUEL S	Imm	Imm	Imm	Imm	Imm
74	411515114075	INDRANIL BANERJEE	Indr	Indr	Indr	Indr	Indr
75	411515114076	IRFAN BASHA H	Irfan	Irfan	Irfan	Irfan	Irfan
76	411515114077	IZAZUDDIN T N	Iza	Iza	Iza	Iza	Iza
77	411515114078	JAMSHEED A M	Jam	Jam	Jam	Jam	Jam
78	411515114079	JAWAHAR S	Jawa	Jawa	Jawa	Jawa	Jawa
79	411515114080	JEBARSON SAMUEL J	Jeb	Jeb	Jeb	Jeb	Jeb
80	411515114081	JEEVA A	Jeeva	Jeeva	Jeeva	Jeeva	Jeeva
81	411515114082	JEFRON G	Jefron	Jefron	Jefron	Jefron	Jefron
82	411515114083	JEGANNADHAN J M	Jeg	Jeg	Jeg	Jeg	Jeg
83	411515114084	JOHN WESLEY V	John	John	John	John	John
84	411515114085	JOSHI DAS L R	Joshi	Joshi	Joshi	Joshi	Joshi
85	411515114086	KARAN S	Karan	Karan	Karan	Karan	Karan
86	411515114087	KARTHICK K	Karth	Karth	Karth	Karth	Karth
87	411515114088	KARTHICK S	Karth	Karth	Karth	Karth	Karth
88	411515114089	KARTHICK S (05-12-1997)	Karth	Karth	Karth	Karth	Karth
89	411515114090	KARTHICK S (14-12-1997)	Karth	Karth	Karth	Karth	Karth
90	411515114091	KARTHIK T	Karth	Karth	Karth	Karth	Karth
91	411515114092	KARTHIKEYAN K	Karthi	Karthi	Karthi	Karthi	Karthi
92	411515114093	KARTHIKEYAN R	Karthi	Karthi	Karthi	Karthi	Karthi
93	411515114094	KARTHIKEYAN V	Karthi	Karthi	Karthi	Karthi	Karthi

94	411515114095	KARTHIK RAJA J	Raja	Reja	Raja	Reja	Raja
95	411515114096	KARTHIKSURYA R	Karthi	Kartha	Karthi	Karthi	Karthi
96	411515114097	KAVIYARASAN R	Kavi	Kava	Kavi	Kavi	Kavi
97	411515114098	KEERTHI T	Keer	Keer	Keer	Keer	Keer
98	411515114099	KESHAVRAM S	Kesh	Kesh	Kesh	Kesh	Kesh
99	411515114100	KIRISHANTH S	Kirish	Kirish	Kirish	Kirish	Kirish
100	411515114101	KOUSHIK A	Koush	Koush	Koush	Koush	Koush
101	411515114102	KOWSHIK S	Kowsh	Kowsh	Kowsh	Kowsh	Kowsh
102	411515114103	KRISHNA PRASATH S	Krish	Krish	Krish	Krish	Krish
103	411515114104	KUMARESAN A	Kumar	Kumar	Kumar	Kumar	Kumar
104	411515114105	LOGARAJAN M	Logar	Logar	Logar	Logar	Logar
105	411515114106	LOGESHWARAN J	Logesh	Logesh	Logesh	Logesh	Logesh
106	411515114107	LOKESH S	Lokesh	Lokesh	Lokesh	Lokesh	Lokesh
107	411515114108	MADHAN S	Madhan	Madhan	Madhan	Madhan	Madhan
108	411515114109	MAGESH A	Magesh	Magesh	Magesh	Magesh	Magesh
109	411515114110	MAHAVISHNU B	Maha	Maha	Maha	Maha	Maha
110	411515114111	MANIVANNAN R	Mani	Mani	Mani	Mani	Mani
111	411515114112	MANOJ S K	Manoj	Manoj	Manoj	Manoj	Manoj
112	411515114113	MANOJKUMAR G	Manoj	Manoj	Manoj	Manoj	Manoj
113	411515114115	MARIA AJITH NITHIYAN P	Maria	Maria	Maria	Maria	Maria
114	411515114116	MOHAMED ASRAF A	Mohamed	Mohamed	Mohamed	Mohamed	Mohamed
115	411515114117	MOHAMED RIYAZ M	Mohamed	Mohamed	Mohamed	Mohamed	Mohamed
116	411515114118	MOHAMED SUHAIL H	Mohamed	Mohamed	Mohamed	Mohamed	Mohamed
117	411515114119	MOHAMMED FAIZAL M	Mohammed	Mohammed	Mohammed	Mohammed	Mohammed
118	411515114120	MOHAMMED HABEEBULLAH N	Mohammed	Mohammed	Mohammed	Mohammed	Mohammed
119	411515114121	MOHAN B	Mohan	Mohan	Mohan	Mohan	Mohan
120	411515114122	MOHAN G	Mohan	Mohan	Mohan	Mohan	Mohan
121	411515114123	MOHAN N	Mohan	Mohan	Mohan	Mohan	Mohan
122	411515114124	MULAKATI SAIPRAKASH	Mulaka	Mulaka	Mulaka	Mulaka	Mulaka
123	411515114125	MUTHUSAMY M	Muthu	Muthu	Muthu	Muthu	Muthu
124	411515114126	NAVEEN KUMAR A	Naveen	Naveen	Naveen	Naveen	Naveen
125	411515114127	NAVEEN KUMAR J	Naveen	Naveen	Naveen	Naveen	Naveen
126	411515114128	NAVEEN KUMAR M S	Naveen	Naveen	Naveen	Naveen	Naveen

127	411515114129	NAVEEN KUMAR V	Kumar	Kumar	Kumar	Kumar	Kumar
128	411515114130	NAVIN N	Navin	Navin	Navin	Navin	Navin
129	411515114131	NIJANDHAN J	Nijandhan	Nijandhan	Nijandhan	Nijandhan	Nijandhan
130	411515114132	NIKESH C	Nikesh	Nikesh	Nikesh	Nikesh	Nikesh
131	411515114133	NISHANTH M	Nishanth	Nishanth	Nishanth	Nishanth	Nishanth
132	411515114134	NITHISH KUMAR R	Nithish	Nithish	Nithish	Nithish	Nithish
133	411515114135	PARAMESHWARA N K	Parameshwara	Parameshwara	Parameshwara	Parameshwara	Parameshwara
134	411515114136	PARTHASARATHY K	Parthasarathy	Parthasarathy	Parthasarathy	Parthasarathy	Parthasarathy
135	411515114137	PARTHASARATHY S	Parthasarathy	Parthasarathy	Parthasarathy	Parthasarathy	Parthasarathy
136	411515114138	PARTHEEBAN D	Partheeban	Partheeban	Partheeban	Partheeban	Partheeban
137	411515114139	PAVITHRAN S	Pavithran	Pavithran	Pavithran	Pavithran	Pavithran
138	411515114140	PERIYASAMY S	Periyasamy	Periyasamy	Periyasamy	Periyasamy	Periyasamy
139	411515114141	PRABAGARAN S	Prabakaran	Prabakaran	Prabakaran	Prabakaran	Prabakaran
140	411515114142	PRABHU K	Prabhu	Prabhu	Prabhu	Prabhu	Prabhu
141	411515114143	PRADEEP M	Pradeep	Pradeep	Pradeep	Pradeep	Pradeep
142	411515114144	PRADEEP R	Pradeep	Pradeep	Pradeep	Pradeep	Pradeep
143	411515114145	PRADEEP V	Pradeep	Pradeep	Pradeep	Pradeep	Pradeep
144	411515114146	PRAGADEESH V	Pragadeesh	Pragadeesh	Pragadeesh	Pragadeesh	Pragadeesh
145	411515114147	PRAKASH G	Prakash	Prakash	Prakash	Prakash	Prakash
146	411515114148	PRAKASH K	Prakash	Prakash	Prakash	Prakash	Prakash
147	411515114149	PRASANAH KUMAR S K	Prasanna	Prasanna	Prasanna	Prasanna	Prasanna
148	411515114150	PRASANNA S	Prasanna	Prasanna	Prasanna	Prasanna	Prasanna
149	411515114151	PRASANTH S	Prasanth	Prasanth	Prasanth	Prasanth	Prasanth
150	411515114152	PRAVEEN G V	Praveen	Praveen	Praveen	Praveen	Praveen
151	411515114153	PRAVEEN KUMAR D	P. Praveen	P. Praveen	P. Praveen	P. Praveen	P. Praveen
152	411515114154	PRAVEEN KUMAR P	P. Praveen	P. Praveen	P. Praveen	P. Praveen	P. Praveen
153	411515114156	PRAVEENRAJ R	Praveen	Praveen	Praveen	Praveen	Praveen
154	411515114157	PRAVIN N D	P. Pravin	P. Pravin	P. Pravin	P. Pravin	P. Pravin
155	411515114158	PREMKUMAR S	Premkumar	Premkumar	Premkumar	Premkumar	Premkumar
156	411515114159	PUVIYARASAN J M	J. M. Puviyarasan	J. M. Puviyarasan	J. M. Puviyarasan	J. M. Puviyarasan	J. M. Puviyarasan
157	411515114160	RAAJIV S	Rajiv	Rajiv	Rajiv	Rajiv	Rajiv
158	411515114161	RAGHURAMA CHANDRAN L	Raghurama	Raghurama	Raghurama	Raghurama	Raghurama
159	411515114162	RAGUL D	Ragul	Ragul	Ragul	Ragul	Ragul

160	411515114163	RAHUL RISHI M	Rahul	Ruhl	Rdhl	Rull	Rdhl
161	411515114164	RAJAP	Raj c	Rjic	Rjca	Rjcc	Rjcc
162	411515114165	RAJAGURU V	Rajaku	Rajaku	Rajaku	Rajaku	Rajaku
163	411515114166	RAJ KUMAR M	Raj	Raj	Raj	Raj	Raj
164	411515114167	RAKESH M	Raksh	Rak	Rak	Rak	Rak
165	411515114168	RAMANATHAN K	Raman	Raman	Raman	Raman	Raman
166	411515114169	RANJITH A	Ranjit	Ranji	Ranj	Ranj	Ranj
167	411515114170	RATHISH RAJ R	Raji	Rja	Rja	Rja	Rja
168	411515114171	RAVICHANDRAN K	Ravi	Ravi	Ravi	Ravi	Ravi
169	411515114172	REMI A	Remi	Remi	Remi	Remi	Remi
170	411515114173	ROHITH RAJENDRAN	Rohit	Rohit	Rohit	Rohit	Rohit
171	411515114174	SABAREESH P B	Sabar	Sabar	Sabar	Sabar	Sabar
172	411515114175	SABARINATHAN T	Sabar	Sabar	Sabar	Sabar	Sabar
173	411515114176	SACHIN PRAKASH R	Sachin	Sachin	Sachin	Sachin	Sachin
174	411515114177	SAI PRATAP D	Sai	Sai	Sai	Sai	Sai
175	411515114178	SAKTHIDHASAN M	Sakthi	Sakthi	Sakthi	Sakthi	Sakthi
176	411515114179	SAM JOE J	Sam	Sam	Sam	Sam	Sam
177	411515114180	SANJEEVI M	Sanjeev	Sanjeev	Sanjeev	Sanjeev	Sanjeev
178	411515114181	SANTHAKUMAR C	Santhak	Santhak	Santhak	Santhak	Santhak
179	411515114182	SANTHOSH C G	Santhosh	Santhosh	Santhosh	Santhosh	Santhosh
180	411515114183	SARAN S	Saran	Saran	Saran	Saran	Saran
181	411515114185	SATHISH M	Sathish	Sathish	Sathish	Sathish	Sathish
182	411515114186	SATHISH R	Sathish	Sathish	Sathish	Sathish	Sathish
183	411515114188	SATHISH KUMAR S (30-07-1998)	Sathish	Sathish	Sathish	Sathish	Sathish
184	411515114189	SATHYANARAYAN AN S	Sathy	Sathy	Sathy	Sathy	Sathy
185	411515114190	SATHYA NARAYANAN D	Sathya	Sathya	Sathya	Sathya	Sathya
186	411515114191	SAURAV KUMAR	Saurav	Saurav	Saurav	Saurav	Saurav
187	411515114192	SELVARAJ S	Selva	Selva	Selva	Selva	Selva
188	411515114193	SEZHIYAN P	Sezhiyan	Sezhiyan	Sezhiyan	Sezhiyan	Sezhiyan
189	411515114194	SHAMER BIN HUSSAIN M	Shamer	Shamer	Shamer	Shamer	Shamer
190	411515114195	SHIVANESAN B	Shivan	Shivan	Shivan	Shivan	Shivan
191	411515114196	SIMIYON SAMUVEL E	Simiyon	Simiyon	Simiyon	Simiyon	Simiyon
192	411515114197	SIVA E	Siva	Siva	Siva	Siva	Siva

193	411515114198	SIVAMANIKANAD AN M	Siva	Siva	Siva	Siva	Siva
194	411515114199	SIVASANKARAN R	Siva	Siva	Siva	Siva	Siva
195	411515114200	SRIKARTHICK A	Srika	Srika	Srika	Srika	Srika
196	411515114201	SRIRAM R	Sri	Sri	Sri	Sri	Sri
197	411515114202	SUBASH K	Suba	Suba	Suba	Suba	Suba
198	411515114203	SUDIR S	Suda	Suda	Suda	Suda	Suda
199	411515114204	SUKRAM M	Suka	Suka	Suka	Suka	Suka
200	411515114205	SUNDAREESHWAR AN J	Sunda	Sunda	Sunda	Sunda	Sunda
201	411515114206	SURENDAR R	Sura	Sura	Sura	Sura	Sura
202	411515114207	SURENDAR S	Sura	Sura	Sura	Sura	Sura
203	411515114208	SURESH B	Suresh	Suresh	Suresh	Suresh	Suresh
204	411515114209	SURESH T	Suresh	Suresh	Suresh	Suresh	Suresh
205	411515114210	SURYA M	Surya	Surya	Surya	Surya	Surya
206	411515114211	SURYA PRASATH G S	Surya	Surya	Surya	Surya	Surya
207	411515114212	SYED SADDAM ALI	Syed	Syed	Syed	Syed	Syed
208	411515114213	TAMILSELVAN S	Tamil	Tamil	Tamil	Tamil	Tamil
209	411515114214	TAMILVANAN S	Tamil	Tamil	Tamil	Tamil	Tamil
210	411515114215	THIRUMALAI E	Thiru	Thiru	Thiru	Thiru	Thiru
211	411515114216	THIYAGARAJAN V	Thiya	Thiya	Thiya	Thiya	Thiya
212	411515114217	UDHAYA KUMAR A	Uday	Uday	Uday	Uday	Uday
213	411515114218	VASUMADHAN V	Vasu	Vasu	Vasu	Vasu	Vasu
214	411515114219	VIGASH R	Vigash	Vigash	Vigash	Vigash	Vigash
215	411515114220	VIGNESH G	Vignesh	Vignesh	Vignesh	Vignesh	Vignesh
216	411515114221	VIGNESH K	Vignesh	Vignesh	Vignesh	Vignesh	Vignesh
217	411515114222	VIGNESH M	Vignesh	Vignesh	Vignesh	Vignesh	Vignesh
218	411515114223	VIGNESH S	Vignesh	Vignesh	Vignesh	Vignesh	Vignesh
219	411515114224	VIGNESH V	Vignesh	Vignesh	Vignesh	Vignesh	Vignesh
220	411515114225	VIGNESH KUMAR S	Vignesh	Vignesh	Vignesh	Vignesh	Vignesh
221	411515114227	VIJAY R	Vijay	Vijay	Vijay	Vijay	Vijay
222	411515114228	VIJAYAKUMAR R	Vijay	Vijay	Vijay	Vijay	Vijay

Coordinator



Dr. R. PALSON KENNEDY, M.E., Ph.D.
PRINCIPAL
PERI INSTITUTE OF TECHNOLOGY
Mannivakkam, Chennai - 600 048

HOD/MECH

Head of the Department
Dept. of Mechanical Engg.
PERI INSTITUTE OF TECH.
Mannivakkam, Ch. 600 048.

PERI INSTITUTE OF TECHNOLOGY
DEPARTMENT OF MECHANICAL ENGINEERING
FEEDBACK FORM

ACADEMIC YEAR 2018-2019

Name of the Student: *Sam Jobi*

Year: *IV*

Course Name: *CATIA*

Register No: *411515114177*

Date of Feedback: *04.05.19*

1. How do you value the course content?

It was good

2. How would you understand the content delivery by the instructor?

There reaction as our

3. Write the overall quality of the program

It is good

4. Will you recommend this program to your friends/juniors/seniors?

Juniors

Suggestions to improve, if any: *nil*

So
Signature of the Student

PERI INSTITUTE OF TECHNOLOGY
DEPARTMENT OF MECHANICAL ENGINEERING
FEEDBACK FORM

ACADEMIC YEAR 2018-2019

Name of the Student: SAJ PRATAP D

Register No: A11515114177

Year: IV

Date of Feedback: 06-05-19

Course Name: CATIA

1. How do you value the course content?

It was valuable

2. How would you understand the content delivery by the instructor?

Those things are not

3. Write the overall quality of the program

It is good

4. Will you recommend this program to your friends/juniors/seniors?

Friends

Suggestions to improve, if any: nil

Sai
Signature of the Student

PERI INSTITUTE OF TECHNOLOGY
DEPARTMENT OF MECHANICAL ENGINEERING
FEEDBACK FORM

ACADEMIC YEAR 2018-2019

Name of the Student: SIVAMANIKAVADAN -M

Register No: 41151124198

Year: IV/

Date of Feedback: 04/05/19

Course Name: ~~MEW005~~ CATIA

1. How do you value the course content?

The value is very important very useful.

2. How would you understand the content delivery by the instructor?

The content is important in your life delivery by the instructor

3. Write the overall quality of the program

The overall quality improvement in your knowledge

4. Will you recommend this program to your friends/juniors/seniors?

seniors.

Suggestions to improve, if any: not applicable.



Signature of the Student

PERI INSTITUTE OF TECHNOLOGY
DEPARTMENT OF MECHANICAL ENGINEERING

ACADEMIC YEAR 2018-2019

Assessment Test

Course code and Name: MEW005 CATIA

Sam Joe J
411515114199

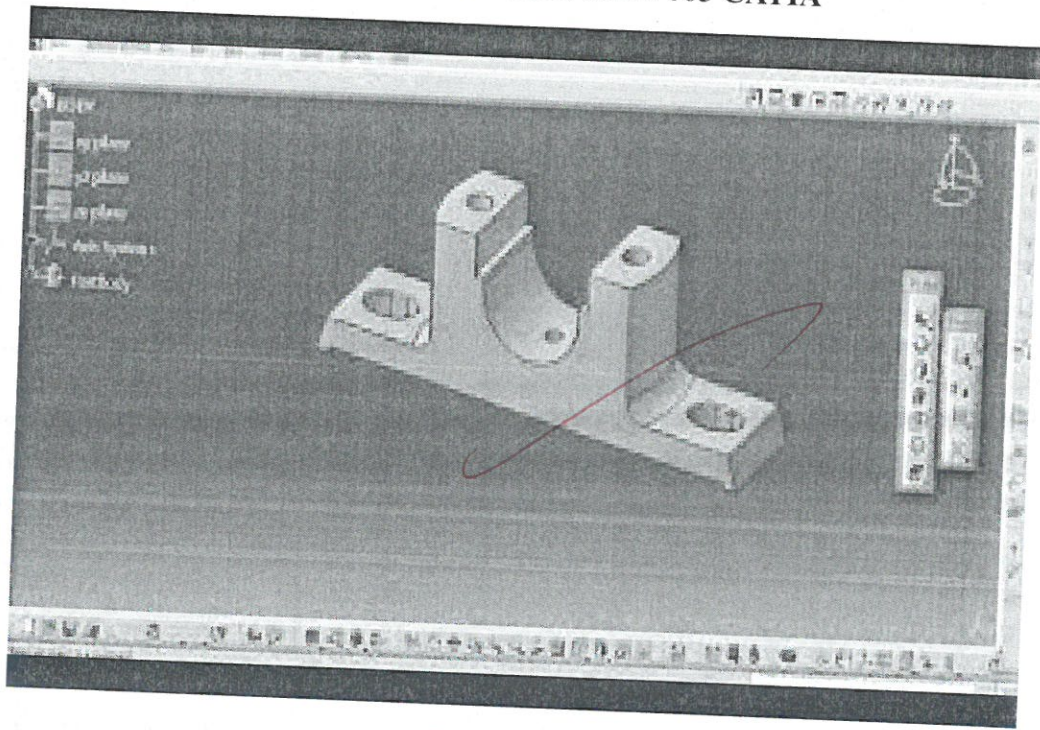

94

100

Sam Joe J
411515114199

PERI INSTITUTE OF TECHNOLOGY
DEPARTMENT OF MECHANICAL ENGINEERING

ACADEMIC YEAR 2019-2020

Assessment Test

Course code and Name: MEW005 CATIA

SAI PRATAP.

411515114177

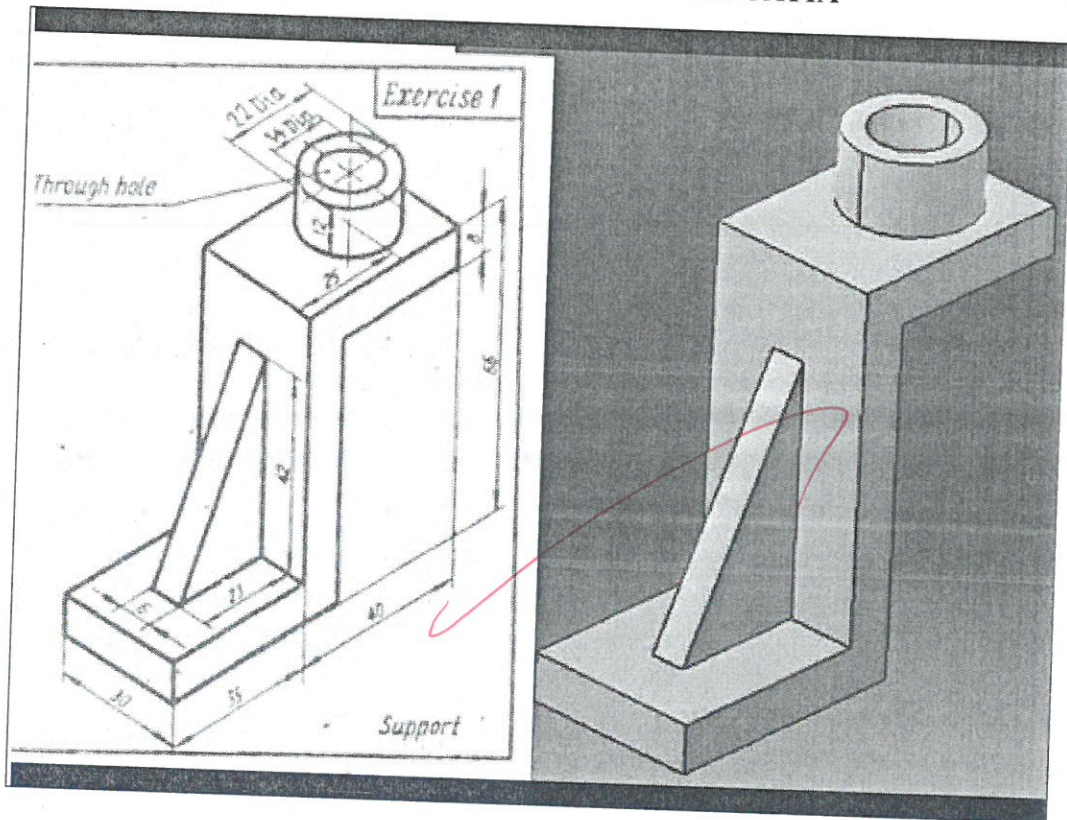

87
100

Signature
4/5/19

SIVAMANICANDANIM

IY yr
411515114198

PERI INSTITUTE OF TECHNOLOGY
DEPARTMENT OF MECHANICAL ENGINEERING
ACADEMIC YEAR 2019-2020

Assessment Test

Course code and Name: MEW006 CATIA

85
100

Jacey

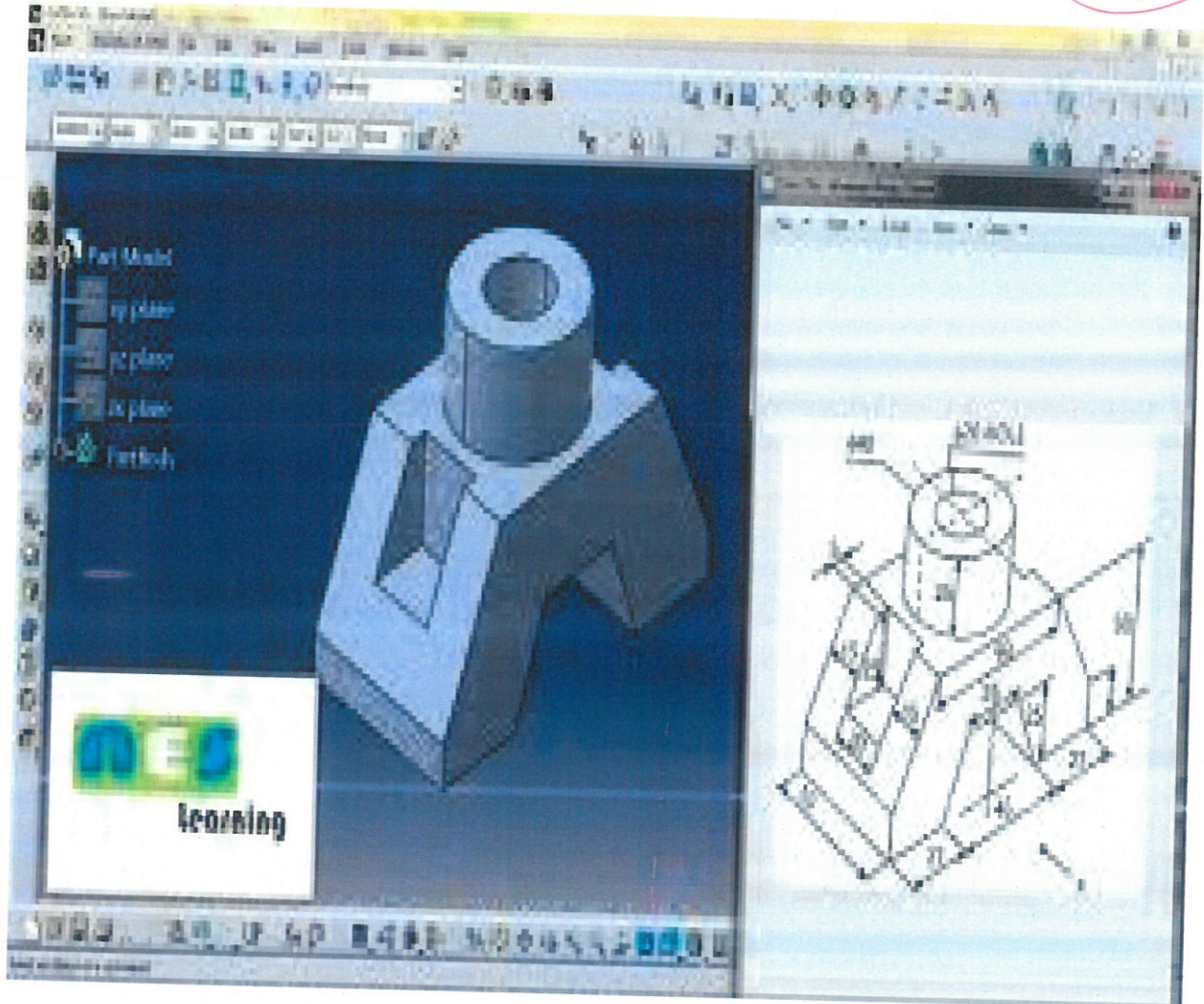

PERI

INSTITUTE OF TECHNOLOGY

DEPARTMENT OF MECHANICAL ENGINEERING

Organizes

Workshop
"CATIA"

CERTIFICATE OF PARTICIPATION

This is to certify that Mr / Ms. SAM JOE . J
of IV Year, Mechanical Engineering, PERI Institute of Technology has completed an
Workshop in **CATIA** held from 22/03/2019 to 04/05/2019



PRINCIPAL



VICE PRINCIPAL



HOD



COORDINATOR

PERI

INSTITUTE OF TECHNOLOGY

DEPARTMENT OF MECHANICAL ENGINEERING

Organizes

Workshop
"CATIA"

CERTIFICATE OF PARTICIPATION

This is to certify that Mr / Ms. SAIPRATAP . D
of IV Year, Mechanical Engineering, PERI Institute of Technology has completed an
Workshop in **CATIA** held from 22/03/2019 to 04/05/2019



PRINCIPAL



VICE PRINCIPAL



HOD



COORDINATOR

www.peri.education

PERI Knowledge Park, Mannivakkam, Chennai - 600048

PERI

INSTITUTE OF TECHNOLOGY

DEPARTMENT OF MECHANICAL ENGINEERING

Organizes

Workshop
"CATIA"

CERTIFICATE OF PARTICIPATION

This is to certify that Mr / Ms. SIYAMANI KANADAN.M
of IV Year, Mechanical Engineering, PERI Institute of Technology has completed an
Workshop in **CATIA** held from 22/03/2019 to 04/05/2019



PRINCIPAL



VICE PRINCIPAL



HOD



COORDINATOR

www.peri.education

PERI Knowledge Park, Mannivakkam, Chennai - 600048